



This is a digital copy of a book that was preserved for generations on library shelves before it was carefully scanned by Google as part of a project to make the world's books discoverable online.

It has survived long enough for the copyright to expire and the book to enter the public domain. A public domain book is one that was never subject to copyright or whose legal copyright term has expired. Whether a book is in the public domain may vary country to country. Public domain books are our gateways to the past, representing a wealth of history, culture and knowledge that's often difficult to discover.

Marks, notations and other marginalia present in the original volume will appear in this file - a reminder of this book's long journey from the publisher to a library and finally to you.

### **Usage guidelines**

Google is proud to partner with libraries to digitize public domain materials and make them widely accessible. Public domain books belong to the public and we are merely their custodians. Nevertheless, this work is expensive, so in order to keep providing this resource, we have taken steps to prevent abuse by commercial parties, including placing technical restrictions on automated querying.

We also ask that you:

- + *Make non-commercial use of the files* We designed Google Book Search for use by individuals, and we request that you use these files for personal, non-commercial purposes.
- + *Refrain from automated querying* Do not send automated queries of any sort to Google's system: If you are conducting research on machine translation, optical character recognition or other areas where access to a large amount of text is helpful, please contact us. We encourage the use of public domain materials for these purposes and may be able to help.
- + *Maintain attribution* The Google "watermark" you see on each file is essential for informing people about this project and helping them find additional materials through Google Book Search. Please do not remove it.
- + *Keep it legal* Whatever your use, remember that you are responsible for ensuring that what you are doing is legal. Do not assume that just because we believe a book is in the public domain for users in the United States, that the work is also in the public domain for users in other countries. Whether a book is still in copyright varies from country to country, and we can't offer guidance on whether any specific use of any specific book is allowed. Please do not assume that a book's appearance in Google Book Search means it can be used in any manner anywhere in the world. Copyright infringement liability can be quite severe.

### **About Google Book Search**

Google's mission is to organize the world's information and to make it universally accessible and useful. Google Book Search helps readers discover the world's books while helping authors and publishers reach new audiences. You can search through the full text of this book on the web at <http://books.google.com/>

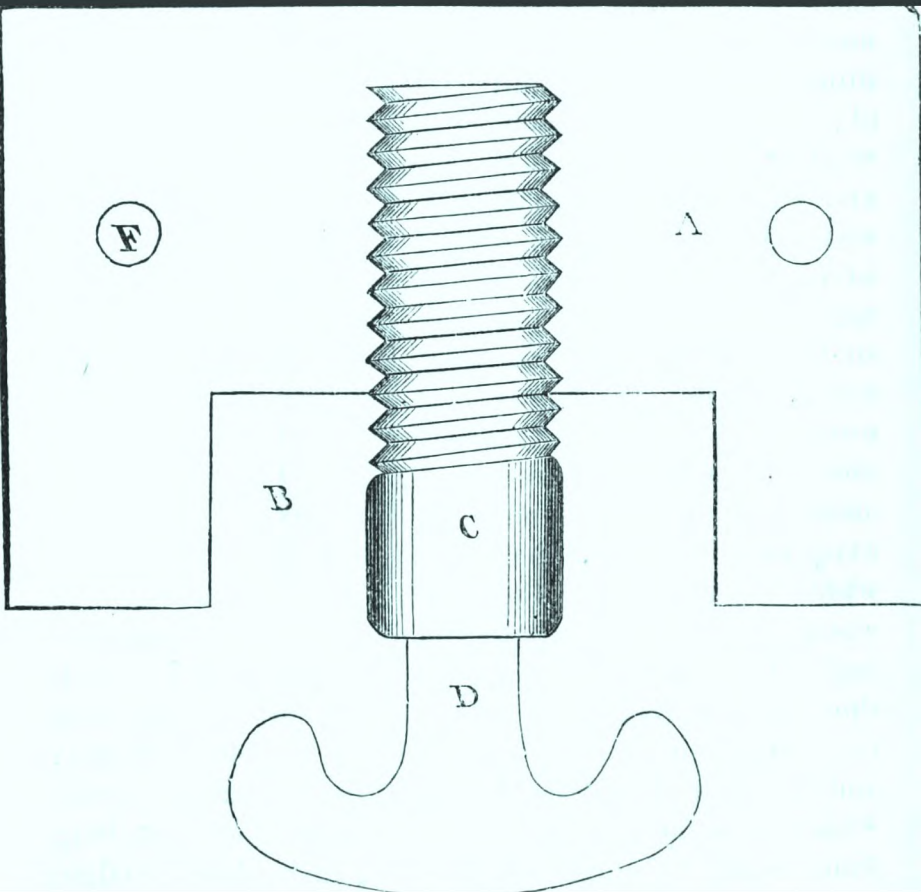

*A Manual of military telegraphy  
for the Signal Service, United ...*

United States. Army. Signal Corps







W. A. Richardson,

Compliments  
Albert J. Meyer  
Capt. 7th Regt.



⊙

A M A N U A L

OF

# MILITARY TELEGRAPHY

FOR THE

SIGNAL SERVICE, UNITED STATES <sup>—</sup>ARMY,

EMBRACING

PERMANENT AND FIELD LINES.

PREPARED UNDER THE DIRECTION OF THE  
CHIEF SIGNAL OFFICER OF THE ARMY.

---

*c'*  
WASHINGTON:

GOVERNMENT PRINTING OFFICE.

1872.



Eng 4348.72.2

1872, Oct. 24.

Gift of  
Hon. Wm. A. Richardson,  
of Washington.  
(N. U. 1843.)

## INTRODUCTION.

---

This work is, as its title indicates, a manual of military telegraphy, and is intended merely to furnish to officers of the United States Army such information as will enable them to establish and maintain telegraphic communication between forces in the field or points covered by military operations, as between the center and wings of an army, or an army and its base of operations, including, of course, intermediate points in either case.

The Morse or American system of telegraphy is the one proposed, and no attention is paid to others. Two kinds of lines are described, but they differ merely in weight and size of material and equipment: one intended for continued use upon fixed routes, being the ordinary American line, and herein called permanent, and the other intended for use with moving columns, being composed of lighter materials, more simply equipped, portable, capable of being rapidly erected and as rapidly taken down, and provided with means of transportation, and a drilled force to handle it, denominated field-lines

Sufficient elementary information is given to enable the student to understand the principles which underlie the work he has to perform, without attempting a scientific treatise, and technicalities have been avoided as far as seemed practicable. Reference is made to works on electrics and telegraphy for information of a character too purely scientific to be embraced in this manual, chiefly to the *Modern Practice of Telegraphy*, by F. L. Pope, esq.

The two varieties of lines are treated of separately, and each in the same manner: materials of line, method of preparation, tools for and method of erection, equipment, method of working, and, in case of field-lines, drill of the force.

The compiler is indebted to the courtesy of Messrs. D. Van Nostrand and L. G. Tillotson for many of the illustrations.

# TABLE OF CONTENTS.

## PART I.

	Page.
CHAPTER I.—Materials for permanent lines :	
Supports, posts, timber for, how prepared .....	9
trees, buildings .....	10
Insulators, materials of, forms of, mode of attaching, comparative value of.....	11
Line-wire, material of, size of, quality of, weight per mile, how prepared for use.....	17
Wire for office use, insulated .....	19
CHAPTER II.—Tools and appliances :	
Tools for digging post-holes, for raising and setting posts, reels .....	21
for making joints or connections, climbers, pulleys.....	24
CHAPTER III.—Equipment of line :	
Batteries, voltaism or galvanism .....	27
main, Grove's, Bunsen's, Daniell's .....	28
insulation and care of, stands .....	34
Instruments, Morse, key, relay, sounder .....	35
tables, switches, lightning-guards .....	38
ground-wires.....	39
CHAPTER IV.—Labor of building, how organized :	
Digging post-holes, procuring posts .....	41
Attaching insulators, erecting posts .....	42
Putting up wire, connecting wire .....	43
CHAPTER V.—Maintenance and working :	
Patrols or repairers ; repairs, how to make.....	46
Organization of working force .....	46
Directions for working .....	47

## PART II.

## CHAPTER VI.—Materials for field-lines :

	Page.
Supports, lances, trees.....	51
Insulators, forms of, and material for .....	52
substitutes for regular .....	54
Wire, iron, compound, insulated.....	54

## CHAPTER VII.—Equipment and tools :

Instruments .....	57
Batteries, Signal Corps patterns.....	58
Ground-bars .....	61
Tools, marking-pins, crowbars, ice-bars.....	62
Climbers, reels, &c. ....	63

## CHAPTER VIII.—The train :

Battery-wagon .....	65
Wire-wagon .....	65
Lance-truck .....	66
Full train, section train.....	66
The detachment, how organized and worked.....	67

## CHAPTER IX.—Drill and illustrations..... 72

## CHAPTER X.—Working the line :

Opening station, terminal or way .....	87
The code.....	88
Working directions, calls, breaks, &c. ....	89
Adjustment, escape.....	93

## CHAPTER XI:

Breaks, grounds, crosses .....	96
Testing.....	96

---

---

PART I.

---

PERMANENT LINES.

---

---



# MANUAL OF MILITARY TELEGRAPHY.

---

## CHAPTER I.

Materials for permanent lines are :

First, supports; which may be considered as of three kinds only, viz, posts or poles, growing trees, and buildings; the first-named to be used whenever practicable, the second to expedite matters in building a line, or upon a route where timber of the proper size for posts is difficult to procure or transport, (as in forests where are no roads or bad ones,) and the third in cities or towns where it is not desirable to set posts in the streets.

Posts should be of such timber as is best able to resist decay, such as red cedar or black locust, either of which, if of proper size and well seasoned, can be expected to last from thirty to fifty years; and, failing these, of white cedar, spruce, white oak, chestnut, sassafras, yellow pine, or cypress, all of which may be made to last well, say, from ten to fifteen years. In emergency, and for lines not expected to last for more than two years, almost any timber will answer; even cottonwood can be used for one year. White cedar, spruce, and sassafras are desirable material, being, when seasoned, extremely light, and enduring well.

Posts should be the bolls or stems of young trees, straight, free from large limbs, at least 25 feet in length, and not less than 5 inches in diameter at the top or small end. They should, when practicable, be cut and the bark to be removed six months or more before they are



used, to allow them to season, and this is urged for the double reason that such preparation adds greatly to their endurance when in position in line and reduces the labor (and cost) of transportation and erection. They might be still further guarded against decay by injecting their substance with any of the substances which have the property of coagulating the albumen of the wood, such as carbolic acid, the solution of the sulphate of copper, or others, but the exigencies of military service will seldom permit the delay necessary for these processes.\*

Where posts such as have been described cannot be had, others may be sawed from large timber, and in this case, the sap-wood being removed, the posts will not decay so rapidly during the first year or two, and may be made somewhat smaller. For sawed posts, 25 feet long, 6 inches square at the butt, and 6 by 3 inches at the top, is a good size.

When trees are to be used as supports, care should be taken to select, if possible, such as have but few limbs, and those at a height from the ground exceeding that to which it is desired to raise the line, and sparse foliage or small tops, such being less liable to be moved or thrown down by high winds. In open country, where trees are used, it will be well to trim them very closely, for the purpose of reducing the surface exposed to the wind. A tree-insulator should always be used upon trees, which will be described in its place.

When it is necessary or desirable to use buildings as supports, the line should be run over their tops, resting upon as few supports as possible, and great care must be

---

\* For description of the processes for injecting posts, see Shaffner's Manual, pages 681 and 682; Sabine's Electric Telegraph, page 185, or Prescott, page 258.

taken to attach firmly and insulate well. These are the least desirable of all supports, and rules can scarcely be laid down for their use. The builder must apply general rules, and exercise great care, as lightning-rods, metallic roofs, gutters, water-conductors, and many other such dangers are in his route, and must be avoided or guarded against.

Secondly, insulators ; and upon the quality of these depends the working of the line. By insulation is to be understood the severing in any manner the electric connection between the wire of the line and the earth, except at points where such connection is purposely made, in order that the current be compelled to flow in the wire. This end is to be attained by attaching to the support some non-conducting body, to which the line-wire may be attached.

Strictly speaking, there are no non-conductors, but those substances which are enumerated as such are the worst conductors, and are usually spoken of as non-conductors. (See Pope's *Modern Practice*, page 10.) Such non-conducting bodies are in number many—glass, and all vitrified substances, the resins, dry woods, oils, and all cereous substances, silk, cotton, &c.—but from the list we may select two classes, vitreous substances and resins, as applicable to the purpose, the others, either from their becoming partial conductors when wet, as wood, flax, silk, &c., or from their fluidity at ordinary temperatures, as oils, &c., being valueless, or nearly so. Glass is the substance usually depended on, and its almost universal adoption by telegraph-builders is evidence of its superior practical value. Either simple, or as covering earthenware or porcelain, it is the substance in common use wherever telegraphs have been built, except in subterranean or submarine lines.

One form of insulator is shown by Fig. 1. It consists of a glass cap 4 inches in height,  $1\frac{1}{2}$  inches in diameter

Fig. 1.

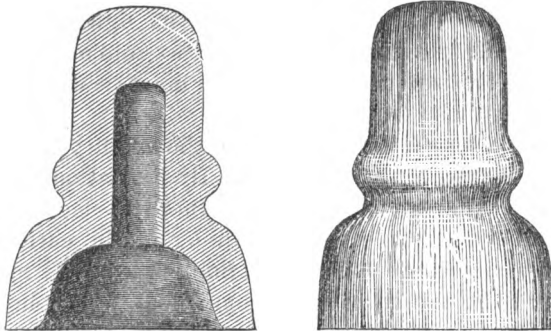

Fig. 2.



at and for  $2\frac{1}{2}$  inches from the top, and of a bell-shape below, so that the diameter at the bottom is 3 inches.

The glass is one-fourth of an inch in thickness. A bead or projection, one-eighth of an inch wide and high, at about one-fourth of an inch above the swell of the bell, forms a seat for the wire, and prevents it from being slipped over the top of the insulator.

This may be attached to the posts by a pin in the top of the post, as shown in Fig. 2, or to the side, as

Fig. 3.

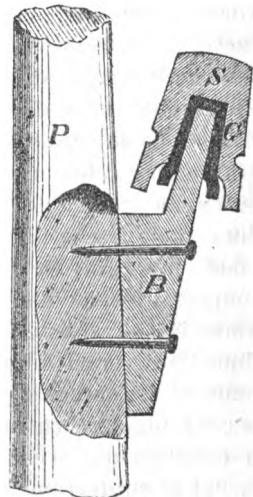

shown by Fig. 3, or by a cross-arm, as shown by Fig. 4. In either case, the glass cap should be made to fit the peg or bracket snugly, so as to be not easily removed; and a good plan is to have the peg or bracket made

slightly smaller than the cavity in the glass, and make the fit by layers of cloth (old tent-cloth will answer) which have been dipped in white-lead and oil. This preparation, when dry, cements glass and wood so firmly that, when the glass is broken by violence, the fragments are often held in place, and so a partial insulation secured. When the peg is used in the top of the post, it should be secured against decay by the same expedient, or some other which will prevent the

Fig. 4.

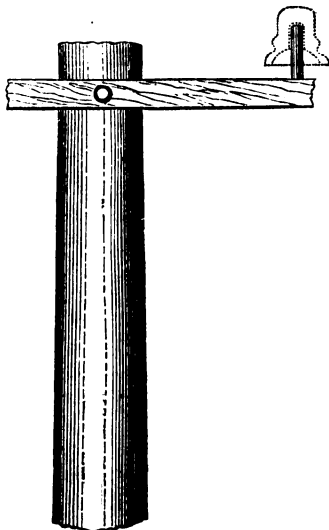

water which falls upon the top of the post, or any portion of it, from finding its way into the hole in which the peg is driven. The bracket is secured to the post by nails or spikes of a size sufficient to hold it firmly, and the post should be flattened, to make a seat for it.

Brackets should be of white ash or oak, one foot long from point to point, cut from  $1\frac{1}{2}$ -inch plank, wedge-shaped, as shown by the figure, one inch wide at the lower point and  $2\frac{1}{2}$  inches wide at the shoulder. The peg or stud on which the insulator is placed should be turned true, of a size to fit loosely in the insulator, and

of a length sufficient to lift the edge of the bell one inch above the shoulder of the bracket. Two holes should be bored through the bracket, to admit the spike, one at a point two inches below the shoulder and the other at one inch from lower end, and both should be bored at right angles to the surface of the bracket which is

Fig. 5.

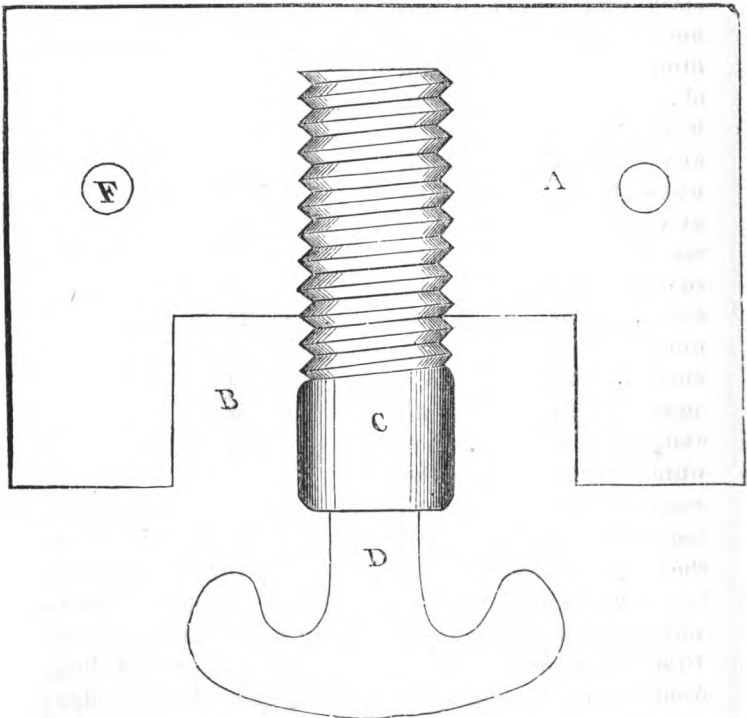

in contact with the post. When cross-arms are to be used, a seat should be cut in the post, a hole bored for the bolt, and the cross-arm secured in position before

the post is erected. If bolts and nuts are not at hand and not easy to procure, cross-arms may be secured to the post by spikes; it is a question of economy, the bolts enduring longer than the spikes.

Insulators may be of glazed earthenware or porcelain, made in substantially the same form as those of glass, and such have been extensively used in Europe, but American telegraphers have not found them profitable, and few are now used. A very convenient form of insulator has been and is used, shown at Fig. 5. It consists of an iron stem terminating in a cross, the extremities of the arms of which are bent at a right angle with the cross, and parallel with the axis of the stem. The other end of the stem, which is about six inches long, is covered for four inches with hard or bone rubber, (so called,) molded into a cylinder, tapering slightly toward the end of the stem and closely embracing and adhering thereto. On the outer surface of the rubber a screw-thread is cut, and the insulator is screwed into a hole bored in the under side of a cross-arm, or of a pine block, spiked to the side of the post, by which it is intended to protect the rubber from moisture. This insulator is strong, cheap, and durable, but it has not been found practicable to exclude moisture so as to preserve the rubber in its best state, and when its surface has become roughened by exposure its value is much reduced.

Paraffine is almost entirely devoid of conducting power or capacity, and is, therefore, in that respect, a desirable substance for use in insulation, but its physical characteristics make the problem difficult of solution. One form of insulator which depends upon this material for its value is shown at Fig. 6. It consists of a hollow cylinder of cast iron, closed at one end, and

having an iron stem, like that described in the preceding paragraph, cemented in its center and projecting beyond its open end. The cement used is composed of non-conductors, one of which is paraffine, and the

Fig. 6.

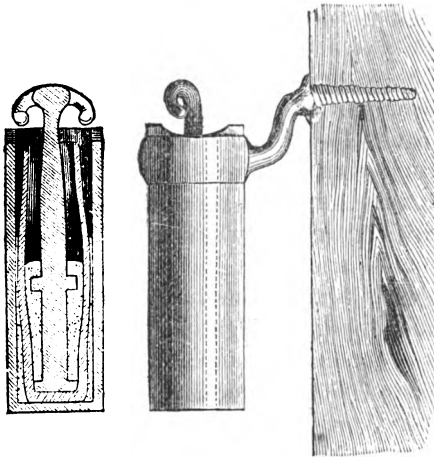

exposed portion of the stem, the surface of the cement, and the inner surface of the iron cylinder are thickly coated with paraffine. This form is costly, but bears a good reputation, and can but be effective if carefully made and used. It may be attached to the poles by be-

being inserted in a hole on the under side of a cross arm or block, like the bone-rubber hook, or the iron shell may be furnished with an arm to screw into a hole bored in the pole.

Another form is that of an earthen cup, strong enough for the purpose, shaped so as to be used in the same manner as the glass insulator heretofore described, and saturated through its entire substance with paraffine. This form has not yet been proved, but would seem a good one for climates in which the heat of summer is too feeble to melt the insulating material.

To all the forms of insulator heretofore described the line-wire is firmly attached, but, as this is not desirable where trees are used as supports, the motion of the tree

endangering the continuity of the wire or the attachment of the insulator, or both, a form has been extensively adopted and used for service upon trees, which consists of a block of glass, 3 inches long by 2 inches wide and high, having projections at each end on three of its sides, and a groove or slot an inch deep traversing its long diameter on the side on which no projections occur. This insulator is attached to a tree by being fitted into the top of a bracket, and the bracket spiked to the tree. When in use it sustains but does not confine the wire, (which merely lies in the groove,) and the glass is protected from wet by a wooden cap nailed upon the bracket. This insulator may also be used on cross-arms by mortising the arm near its end to receive the glass and using the cap. As will be seen, it is not well protected against moisture, and is, in that respect, defective.

As expedients, in the absence of any accepted form of insulator, any non-conductor, so disposed that the line-wire shall come in contact with it and with nothing else, will answer. During dry weather seasoned wood, especially if saturated with resin, may be made to support line-wire, and signals have been successfully transmitted over fifty miles of wire so insulated.

Thirdly. Wire for permanent lines should be of best charcoal-iron, No. 8 standard gauge, though for military uses, having in view saving of weight and facility of putting up, No. 9 or No. 10 may be used for lines of not more than one hundred to two hundred miles in length. It should be annealed, coated with zinc in the manner known as "galvanizing," joined up in half-mile lengths, the joints soldered, the lengths run into coils 18 inches in diameter inside and 6 inches wide on the face of the



coil, and the coils secured by four tie-wires equidistant from each other.

Such wire should show no sign of fracture after being bent, when cold, to a right angle and again straightened, should be free from slivers and splits, and weigh (No. 10) 300, (No. 9) 340, and (No. 8) 380 pounds to the mile length.

The following are some of the qualities required by the English postal department for its standard wire :

1st. The wire supplied under this tender must be of the gauge known as No. 8, Birmingham wire gauge, (diameter .170 of an inch.)

2d. The wire to be highly annealed and very soft and pliable, and to be galvanized. The wire must be capable of elongating 18 per cent. without breaking, after being galvanized.

3d. The wire to be entirely free from scales, inequalities, flaws, splits, and other defects, and to be cylindrical.

4th. No deviation greater than .005 of an inch either way from the prescribed diameter will be allowed.

5th. The whole of the wire to be passed under and over three or more pulleys or fixed studs, placed in such position in the plan indicated as shall, in the opinion of the engineer, admit of the quality of the wire, as regards freedom from splits, being sufficiently tested.

6th. The whole of the wire to be stretched 2 per cent. by machinery, and after being stretched to be coiled carefully, so as to contain no bends or indentations, but in all respects to resemble newly-drawn wire.

The coating with zinc is less important in dry climates than in moist ones, being intended merely as a protection against oxidation, and consequent reduction of the con-

ducting capacity of the wire, but is inexpensive, makes the wire easier to handle, in that it wears the hands of the men who handle it less than the iron, and is of further value in that it aids in making good connections, when line is broken and rejointed after being erected, by preserving a bright surface. This fact becomes of importance where lines are especially liable to damage, and unsoldered joints (made by repairers or patrols) are frequent, as is likely to be the case with military lines.

For that portion of lines which traverses buildings for the purpose of connecting with instruments located therein, or to reach the main batteries, in short, for all in-door work, a copper wire should be used of a size sufficient to be equal in conducting capacity to the line-wire—say, for a line of No. 10 iron wire, a No. 18 copper; No. 9 iron, No. 17 copper; No. 8 iron, No. 16 copper—and such wires always insulated by a covering of silk, cotton, or flax, or of gutta-percha, caoutchouc, or ballata. For ordinary in-door use the silk, cotton, or flax covering is best, as the other materials named deteriorate rapidly in a dry air, becoming brittle and detached from the wire. For passing into and out of buildings, where the fall of water from the roof endangers the insulation of the line, it may be well to use the gums, or some of them, and renew the wires as often as may be necessary to keep them in a proper state of insulation; though, by saturating the fibrous covering with shellac or other resin, or, better still, with paraffine,\* an equally good result may be obtained.

---

\* PARAFFINE, (*Parvum*, little; *affinis*, affinity.)—There are several substances known in commerce under this name. It is usually applied to a white, solid, translucent substance, free from odor and taste, somewhat crystalline in texture, of specific gravity about 0.87,

Where copper wire is connected to iron, the joint must be protected by solder, or in some other manner, from moisture, or a local galvanic action will result, which will at the same time reduce the conductivity of the line, by oxidating the surfaces in contact, and impair its strength. If appliances for soldering are not at hand, the joint can be preserved by smearing it with a paste of white-lead and oil, of raw rubber, or by coating it with paraffine, each of which, however, yields to climatic influences, and is inferior to soldering.

---

melting at about  $122^{\circ}$  Fahrenheit and volatilizing at a high temperature. It is but slightly acted upon by re-agents; hence its name. Its chemical composition is most probably that of a mixture of several hydrides of the higher alcohols, such as cerotene, or cerotic hydride, ( $C_{27}H_{56}$ ), melene, or melenic hydride, ( $C_{30}H_{62}$ ), the lowest in this series being marsh-gas, methylic hydride, ( $C.H_4$ ). Alcoholic hydrides, as they get lower in the series, become liquid at the common temperature, and are then known as paraffine oil. Paraffine is obtained in enormous quantities in the dry distillation of wood, coal-bituminous shale, petroleum, peat, and lignite.—*Rodwell's Dictionary of Science.*

**PARAFFINE.**—Distill beech-tar to dryness, rectify the heavy oil which collects at the bottom of the receiver, and, when a thick matter begins to rise, set aside what is distilled, and urge the heat moderately as long as anything more distills. Pyrolaine passes over, containing crystalline scales of paraffine. This mixture, being digested with its own volume of alcohol, of 0.833, forms a limpid solution, which is to be gradually diluted with more alcohol till its bulk becomes six or eight times greater. The alcohol, which at first dissolves the whole, lets the paraffine gradually fall. The precipitate being washed with cold alcohol till it becomes nearly colorless, and then dissolved in boiling alcohol, is deposited on cooling in minute spangles and needles of pure paraffine.—*Ure's Dictionary of Arts, &c.*

## CHAPTER II.

The tools and appliances for building a permanent line are few, and can be procured easily, most of them being found in any ordinary stock of hardware. They are, first: Axes for felling and preparation of posts, and for clearing the way for the line, where such work is required. Hatchets, having a bit 4 inches wide, a head or poll

Fig. 7. with which to drive spikes,

Fig. 8.



(and weight sufficient to make them effective in that respect, say  $1\frac{1}{2}$  pounds,) and hickory handles 15 inches long. This tool is of use not only in building but maintaining the line—is in fact one, as the plier is the other, of the “line-men tools.” Diggers, (so-called,) which are crow-bars of about 15 pounds weight, having a flat cutting point or edge, (Fig. 7,) for loosening the earth, and shovel, (Fig. 8,) for removing it, in digging post-holes, each being of a length of not less than 5 feet, and the point of the diggers and blade of the shovels being steel. In

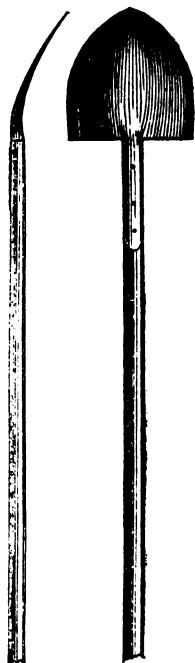

soils where they can be used, post-augers (Fig. 9) should be provided in place of

bars and shovels, as on prairies or alluvial bottoms free from gravel. With this tool one man can do

Fig. 9.



the work of one and a half, using digger and shovel, and the hole may be made so nearly of the same size as the posts to be set therein as to greatly facilitate the erection of the line, saving labor of tamping, &c. Shears, foot-plates, and pikes for erecting, and tamping-bars for setting the posts, are also needed. The shears consists of two pieces of timber 6 feet long and 5 inches wide by 2 inches thick, (less will do if posts are not heavy,) crossed near one end, and firmly secured to each other in such a manner as to form a base 3 feet wide to rest upon the ground, and a saddle upon which to sustain the weight of the post. The foot-plate is a curved plate of iron or steel, having a handle attached like that of a shovel. Its use is to receive the foot of the post while it is being erected, and prevent it from loosening the material of the wall of the hole. The pikes are spruce, pine, or ash poles, 8, 10, and 12 feet in length, and  $1\frac{1}{2}$  inches in diameter, armed at one end with a spike and ferrule, and are to be used in raising posts. Tamping-bars are rammers of hard wood, 5 or 6 feet long, and of a size to be conveniently grasped. They are used to tamp or ram the earth about the post, between it and the walls of the hole, in order that the posts may stand firmly when in place.

Augers for boring the holes in the posts for admitting the peg on which the insulator is set, or those through the post for the admission of the bolts used in attaching cross-arms; saws, if the posts are to be prepared for the reception of cross-arms; wide chisels to cut the seat for the cross-arm, and mallets.

Fig. 10.

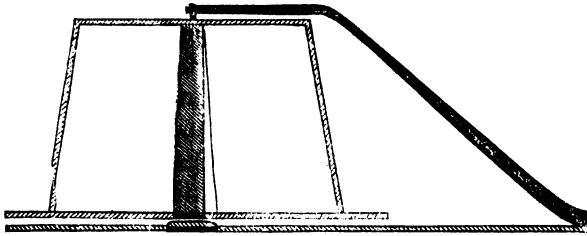

Reels for laying or delivering the wire from the coil, shown at Fig. 10, consist of a base which may rest on the bottom of a wagon, the deck of a platform-car, (if the car is upon a railroad,) or other means of transportation, and the reel proper resting upon this base and turning horizontally upon an axis. The base is a piece of timber 3 feet in length, and 6 inches wide by 2 thick, having a cross-piece of like width and thickness, and 4 feet long, halved on and firmly secured to it at 2 feet from one end. From the center of the point of intersection rises the axis of the reel. This is an iron rod  $1\frac{1}{2}$  inches in diameter and  $2\frac{1}{2}$  feet long. From the extremity of the long arm of the base an iron stay or brace extends to the top of the axis, hinged to the base, and engaging at the top with the axis of the reel, to prevent it from being bent or thrown out of perpendicular by any strain upon the reel. The reel itself consists of two pieces of oak or other hard wood, 3 feet long, 3 inches wide, and

$1\frac{1}{2}$  thick, framed together at right angles to each other at their respective centers, having an iron plate on one side of the intersection, and through the center a hole, for the admission of the axis. Secured to this cross, at such a distance from the center that the coils of wire to be used may drop easily over them, and connected at the top by another cross similar to the one described, except that its arms are shorter and do not extend beyond them, are four uprights of the same size and material as the crosses—the outsides of which are curviform—representing segments of the circle formed by the inside of the wire coils, and are 2 feet in length. When complete, the reel is a skeleton of a frustum of a cone, 2 feet in height, 18 or 20 inches in diameter at its base, and 3 inches less in diameter at its top. When in use it is upon the base described, is retained in position by the axis, and, revolving horizontally, delivers the wire from the coil placed upon and revolving with it, straight and free from torsion, and so not liable to run into kinks if slackened or broken.

Pliers, for making connections in the wire, should be of the kind known as “flat-nosed,” with a cutting blade on the side of the jaw, should be not less than 8 inches

Fig. 11.

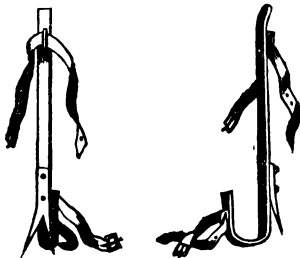

long, strong, and having well-tempered jaws. Files should be 8-inch triangular saw-files. The tool for making joints (or connections) in the wire should be of steel, 6 or 8 inches long, with one lip recurved. In use, the recurved lip embraces the line-wire, while the shoulder rests against the end, which is to be wound round and clasp it. By carrying

the handle of the tool around the line-wire, the end will be snugly compressed upon and coiled around the line, and a smooth joint made.

Tools for soldering joints are an alcohol-lamp of any convenient form, a bottle or other vessel containing muriatic acid, in which zinc has been dissolved as long as the acid will take it up, and solder, in bars of a foot or so in length and half an inch in width and thickness.

Climbers, to enable the men to reach the top of the posts easily, are of various patterns. One or two well

Fig. 12.

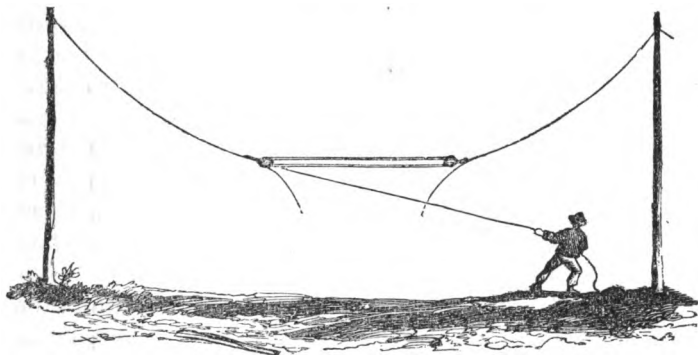

approved are shown at Fig. 11, as is also the mode of attaching them to the feet of the men.

Pulleys, for bringing together the ends of a broken wire, so that a joint or connection can be made, should be furnished. Two blocks, one single and one double, with not less than 50 feet of rope, form the set. Vises, or other devices for grasping the wire, are attached to the block-straps, which, together with the method of reeving, are shown at Fig. 12, and can be better understood by an examination than by the most careful description. In event of vises or other device for holding



the wire being wanting, two ends of pliant rope, the bight of which is through the block-strap, can be made to grasp the wire with sufficient tenacity by winding them around it in long spirals in opposite directions, and tying the extreme ends together, to prevent the unwinding of the spirals. The blocks should be not less than 4 inches long, the sheaves of lignum vitæ, and bushed with brass, and the rope best half-inch Manila hemp.

## CHAPTER III.

### EQUIPMENT OF A LINE.

For the equipment of a line there will be needed batteries, which are to the telegraph what the boiler is to the steam-engine, the source of the motor on which the action of the machinery depends. They are but various forms of the voltaic pile, and the principle upon which all are constructed may be thus stated: When two metals, one more easily oxidized than the other, are subjected to the action of water, a portion of the water is decomposed, the oxygen entering into combination with a portion of the oxidable metal, and a portion of the hydrogen being freed and escaping. At the same time a development of electricity takes place, positive or *plus* electricity being found at the less oxidable of the metals, and negative or *minus* electricity at the other. If the two metals are connected above the water by a metallic conductor, the metals exchange electricities over and along such conductor, and a telegraph line, in miniature, is at once established. In developing the principle thus laid down it may be further stated that the greater the difference between the metals, and the more active the excitant, the greater will be the result in the development of electricity. Zinc is universally used as the positive element in batteries, being easily oxidable, and inexpensive; but copper, silver, platina, and graphite are used as negative elements, and the excitants are almost numberless, varying from pure water to anhydrous acid. For *main batteries*, *i. e.*, those which supply the current that flows upon the line and serve as the means of communication between distant earthenware, equal in height to the glass cup,  $1\frac{1}{4}$  inches

points, one of the most approved forms is that shown at Fig. 13, called, from the name of its inventor, "Grove's." Its cell consists of a glass cup or tumbler, 4 inches in

Fig. 13.

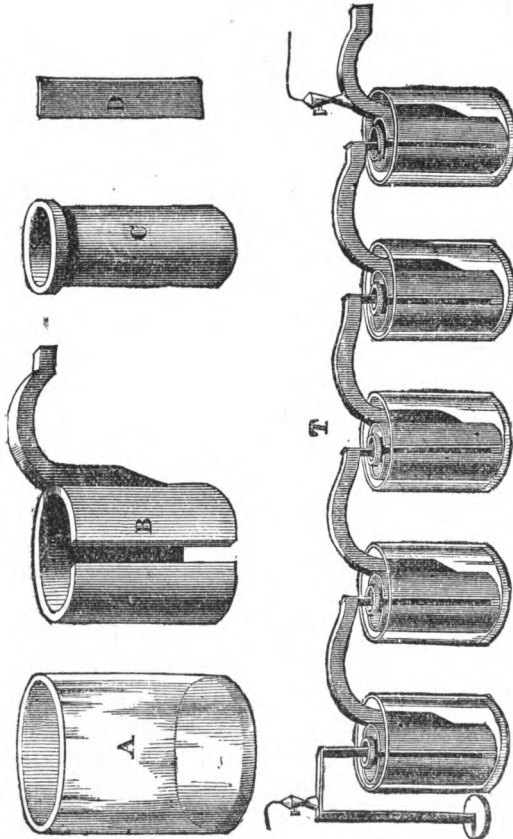

height,  $4\frac{1}{2}$  inches in external diameter, and of a thickness sufficient to give the requisite strength; a cup of porous

in outside diameter at the bottom, and for 3 inches of its height having its top funnel-shaped, and 2 inches in diameter, and with its walls one-eighth of an inch thick. The material of this cup must be porous clay and not vitrified, as it must be traversed freely by the electricity generated in the different cells of the battery or series. The zinc or positive element is in the form of a hollow cylinder divided longitudinally, having projections or feet on which to stand in the cup and an arm rising from its top above the cup and extending horizontally, so that its end shall be over the porous cup in the next cell in the battery. The negative element is a strip or ribbon of platinum permanently attached to the projecting arm of the zinc cylinder.

The size of the zinc and platinum may be varied, but a convenient and effective size is  $3\frac{1}{2}$  inches for the height of the zinc cylinder, and 3 inches for the horizontal length of the arm, both cylinder and arm being one-half inch in thickness, and the latter three-fourths of an inch in width.

The platinum strip for use with such a zinc should be three-fourths of an inch wide and four inches long, and soldered firmly upon the end of the zinc arm. The exciting fluids are water and sulphuric acid, twenty parts by weight of the former to one of the latter, surrounding the zinc and filling the glass cup, and nitric acid surrounding the platinum in the porous cup.

The action of this battery may be thus described: The series being connected one with the other, and the extremities with the conductors, the oxygen of the acidulated water attacks the zinc, forming sulphate of oxide of zinc, which is dissolved as fast as formed, and thus is continued until the solution becomes saturated, when

the oxide is deposited upon the zinc itself, and finally protects it from the action of the oxygen. The flow of electricity then becomes feebler, and finally ceases entirely. The hydrogen freed at the negative (platinum) plate is not permitted to escape or to adhere to the platinum, (by which the conducting power of the battery would be reduced,) but enters into the nitric acid, changing it from nitric to nitrous acid. This battery gives a very steady and powerful current, and is for that reason much used; it is however costly and needs much attention to obtain the best results. The zincs should be amalgamated with mercury by being cleaned in a bath of sulphuric acid and water strong enough to boil them, and then dipped in mercury. This preparation preserves the zincs from local oxidation, consequent upon impurities in the metal, and prevents the deposit of sulphate upon their surfaces. Fifteen cells of Grove's in good order are sufficient to work a line of one hundred miles in length, unless there is a large escape or leakage at some point on the line.

The Bunsen battery (Fig. 14) resembles the Grove in

Fig. 14.

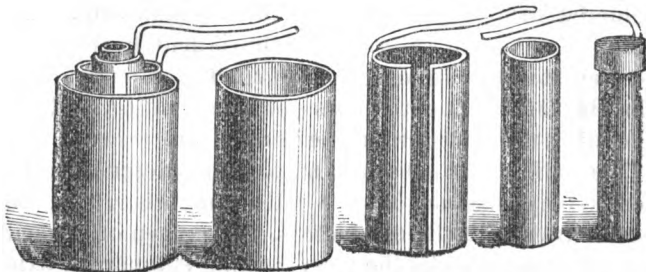

all except the negative element, which is of graphite or other form of carbon, instead of platinum. Its power is

less than that of the Grove, inasmuch as the carbon is a poorer conductor than the strip of platinum, but it is cheaper, and therefore much used, especially on the continent of Europe.

The Daniells battery (Fig. 15) differs from those pre-  
Fig. 15.

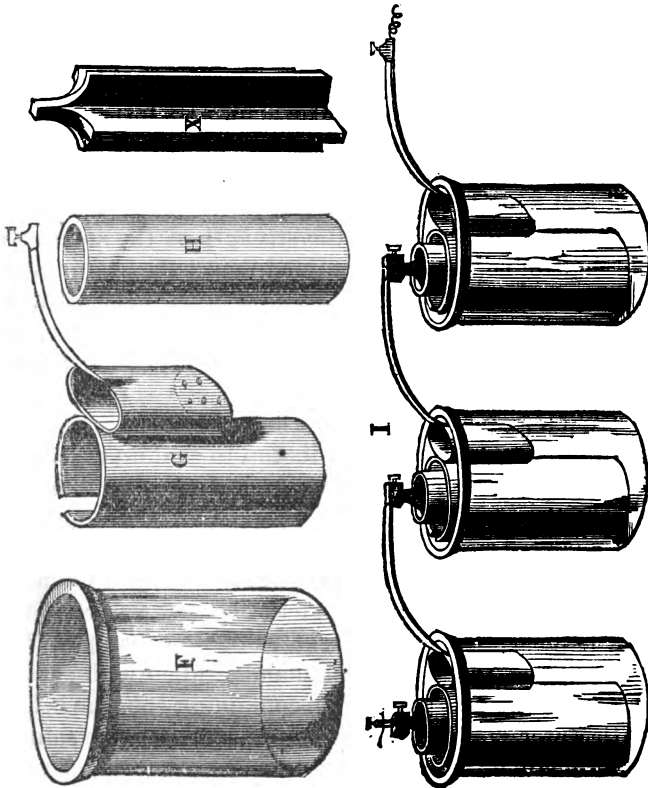

viously described in everything except the use of zinc as the positive element. It is less powerful than the

Grove, and therefore less used in America, where long distances are to be traversed, but is much used in Europe, and is much recommended by its cheapness and the length of time it will remain in action without attention, deriving from this last peculiarity its name of "constant battery." A Daniells cell consists of a copper plate immersed in a solution of sulphate of copper, and a zinc plate immersed in a solution (weak) of sulphate of zinc, or in water to which has been added one-twentieth of its weight of sulphuric acid. Its forms are very numerous, and need not be described here. If the above-named conditions are maintained, the battery will work, and will give about half the force of the same number of Grove cells, (provided the strength of the solution of sulphate of copper is maintained,) until the precipitation of sulphate of zinc clogs the action upon that metal. A form of this battery, intended for military service, consists of a cylindrical copper vessel, the inner surface of which forms the negative element of the pair, having a diameter of 4 inches and a height of 4 inches, with a perforated copper cup near its top to contain crystals of the salt, a leathern porous cup,  $2\frac{1}{2}$  inches in diameter, and of the same height as the copper vessel, attached to an insulated cover, which fits the top of that vessel, and a prism of zinc 8 inches in height and  $1\frac{1}{2}$  in diameter. To place this cell in action, the copper vessel is two-thirds filled with a solution of sulphate of copper, (blue vitriol,) and the perforated chamber filled with crystals of that salt. The porous cup containing the zinc is filled with water slightly acidulated, or with a weak solution of sulphate of zinc, and placed within the copper vessel and the connections made. The solution in the copper vessel should fill it when the porous cup is in position,

in order that the crystals in the perforated chamber may be dissolved.

When electric communication is established, the acidulated water attacks the zinc, as in other batteries, and the freed hydrogen finds an office in reducing the copper from the solution of its salt. The copper resulting from this action is deposited on the surface of the copper element, keeping it bright and preserving its conducting power. The weakening of the solution is prevented by adding fresh crystals as fast as those in the perforated chamber are dissolved, and the battery works with undiminished energy until the water in the porous cup becomes a supersaturated solution of sulphate of zinc, and a deposition of this salt takes place on the zinc itself. This battery has much to recommend it, its constancy alone making it everywhere preferred for locals. For military lines it has the merits of not requiring the transportation of concentrated acids, or such delicate manipulation as the Grove or the Bunsen.\*

---

\* *Note on the chemical action of the Daniells battery.*—When the current passes, the zinc is dissolved, and the copper receives an equivalent increase in weight. In the chamber containing the zinc and acidulated water, the oxygen of each atom of water decomposed unites with an atom of zinc, forming an atom of oxide of zinc, which, in its turn, combines with an atom of sulphuric acid, forming sulphate of zinc, which is dissolved in the water. The atom of hydrogen released is transferred, by means of decompositions and recompositions, toward the copper cylinder. In the interior of the porous cup an equivalent atom of sulphate of copper is decomposed into one atom of copper, one of oxygen, and one of sulphuric acid. The atom of copper is deposited upon the plate by the current; the atom of oxygen, moving toward the zinc plate, meets the atom of hydrogen traveling from the other compartment of the element, and combines with it, forming together an atom of water; while the atom of sulphuric acid goes to the zinc compartment to renew the supply there for the formation of sulphate of zinc, as that metal is dissolved.—*Sabine's Electric Telegraph*, page 222.



Other batteries might be enumerated and described, but the principles involved in their construction are substantially the same as in those already named. The necessary number of cells for any given line can only be determined when the character of the line as to conductivity and loss of current by defective insulation is known, but fifteen cells of Grove or Bunsen, or twenty-five cells of Daniells, are usually sufficient for a line of one hundred miles in length; and if that number of cells, in fair order, fails to give good results, the remedy should be applied in the form of labor on the line, trimming, re-insulating, &c. For lines exceeding one hundred miles in length, one cell of Grove, or two of Daniells, for each additional ten miles of line, should furnish a current of sufficient intensity. The Daniells cell is especially fitted for use as a local battery, two cells being sufficient for each office, or for each set of instruments where more than one is employed.

Main batteries should be as carefully insulated as any part of the line, the cells not allowed to be in contact with each other, and each one mounted on a dry insulating-stand. In one form of stand used the cell rests on the edge of glass strips so arranged as to shed moisture. The efficiency of this form is much increased by coating both wood and glass with paraffine. Another method is to make a battery stand by using an insulator with a flat top as a seat for each cell, and attaching the insulators to a convenient support. The so-called Wade insulator, with wooden shield, is well adapted for this purpose. Local batteries do not need so much care in this respect, as the current generated by them is of low tension, and the circuit offers little resistance; they should, however, be kept in a dry place.

## INSTRUMENTS.

The instruments for equipping a line are the ordinary "Morse" key, relay, and sounder, switches if more than one wire is used, and repeaters if more than one circuit is to be worked. The "Morse" key is a device for conveniently opening and closing the circuit, and is merely a brass lever of any convenient length, usually about 6 inches, having, about 2 inches from one end, a transverse axis or trunnion; at the end of the shorter arm a screw with a binding-nut, for the purpose of regulating the distance through which the lever may move; at the other end a finger-piece, by which it is grasped, of ivory, rubber, or other non-conducting substance, and on the under-side a platinum stud. The lever is mounted by its trunnion on a base so that its set-screw shall be in contact with the base when the front end is raised, and the platinum in stud contact with an insulated anvil, (also armed with platinum,) to which one end of the wire is attached, when pressed down by the finger. The other end of the wire is attached to the metallic base of the key. A lever, held in its place by a spring, makes permanent

Fig. 16.

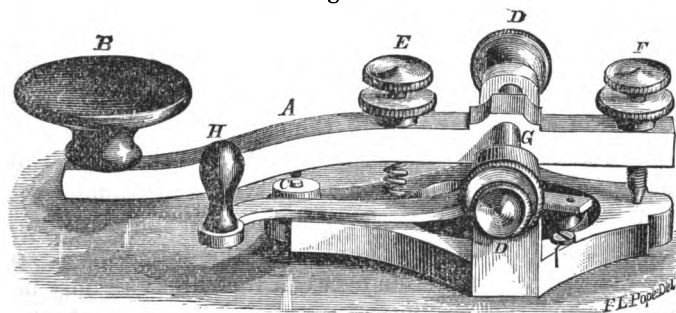

contact, when desired, between the base and the anvil, and is called the "circuit-closer."

The key is held open when not in use by a light spring. An examination of Fig. 16 will enable the student to fully understand the apparatus.

The relay (Fig. 17) is simply an electro-magnet of from five to fifteen miles resistance, and fitted for use on a circuit of high tension, mounted on a flat base, and provided with convenient posts for the attachment of the main line and local wires, and with an armature so

Fig. 17.

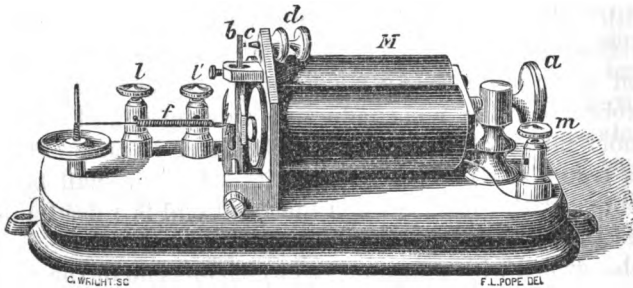

mounted as to be opposite to and within the magnetic field of the poles of the magnet. This armature is provided with a spring, by which it is withdrawn from the poles when the circuit is broken and the attraction ceases. From the bottom of the posts *M* and *m*, connection is made with the wires of the magnet, so that when the line-wires are attached to the posts the magnet is contained in and forms part of the main circuit or route of the current generated by the main batteries. From the posts *l* and *l'* wires are connected with the frame-work that supports the poles of the magnet, and with the armature, which is insulated from the frame-work, so that electrical connection between the wires can only be made when the platinum points, with which both the

armature and the frame-work are armed, are brought into contact, this being part of the local circuit or route of the current generated by the local battery to work the sounder. Relays are of various patterns, but this general description will answer for all, as the principles involved and purpose to be accomplished are the same in all forms.

The sounder (Fig. 18) is also an electro-magnet, mounted conveniently, with armature, spring, connecting-posts, &c., like the relay, but differing from that instrument in the character of the magnet and the uses to which it is put. Its magnet is one of very slight resistance, and therefore fitted for use only in a current of low tension, such as that generated by the local battery, (by which its action is controlled,) and repeats its signals so loudly as to render them distinctly audible, and thus reduce the difficulty of receiving or recognizing them.

Fig. 18.

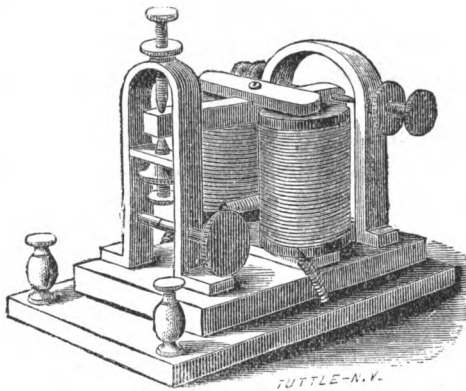

Repeaters are a class of instruments rendered necessary by the difficulty of working circuits of more than two to three hundred miles in length, and are used to repeat automatically in a second circuit the signals made in the first by the manipulation of the key, each repeater performing the work of a receiving and a trans-

mitting operator, thus reducing cost and the chances of error. They are of various kinds, and need not be described in this work, it being sufficient to say that all of them accomplish their purpose by making the armature of a sounder perform the office of a key in a circuit other than that in which the magnets of the sounder are connected.

Instrument-tables may be of any convenient form, and military lines will usually be roughly furnished in this respect, but a good form is  $2\frac{1}{2}$  feet in length by  $1\frac{1}{2}$  in breadth and  $2\frac{1}{2}$  high, with a drawer to contain stationery, &c. Such a table is large enough for a set of instruments, and gives room for convenient copying of messages.

Switch-boards are needed where several wires enter an office, and are merely devices by which any instrument in the office may be connected with any line-wire, or, in case of an office intermediate between the terminals, by which line-wires on one side can be interchanged with those on the other. They are of various kinds, but the main features of all are similar. A board, having brass strips extending vertically across one surface, equal in number to the line-wires to be attached thereto, with screw-posts at the ends of the strips, has also, between the strips, buttons hanging on pivots, (all of brass,) which pivots extend through to the back of the board, and are connected by a wire with one another in horizontal rows, and each row to a screw-post at the side of the board, to which the wires which reach the instruments and batteries are attached. It will be seen that when one of these buttons is turned to right or left, so as to touch a strip, the connection is complete from the line to the instruments and batteries, and that, as each row of buttons crosses all the strips, it is prac-

ticable to make any connections desired. Various other convenient arrangements can be made, such as bringing battery and ground wires

Fig. 19.

into switch-boards; arrangements for loops, by which an instrument placed elsewhere than in the office can be, at will, switched into any circuit on the board; tests made of wires, &c. The switch

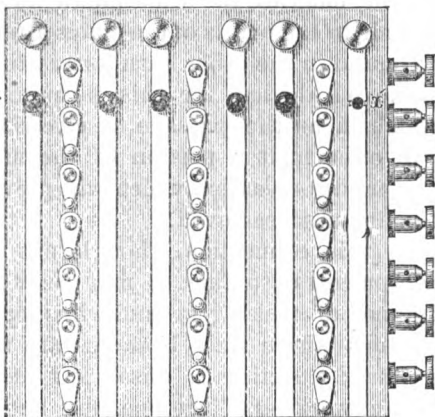

thus briefly described is known by American telegraphers as the "Culgan switch," (Fig. 19.)

Lightning-guards are devices by which atmospheric electricity, gathered by the line-wire, is removed therefrom and conducted to earth without injury to the apparatus or operators. They are of various forms, the object in all being to present near the line-wire, and between it and the instrument-tables, a route over which the atmospheric electricity can reach the earth, and this can be done readily, because that electricity will leap over or through short spaces without a conductor. One form brings the line-wire to a plate of metal having a serrated edge and a ground-wire to another such plate, the two plates being secured upon a base of non-conducting material with their points separated by a space not exceeding the one-thirty-second of an inch. Another is to connect the line-wire with a metallic disk, and the

ground-wire with another, the disks being pressed together by a gripe or clamp, but prevented from coming in contact by a disk of thin paper or of silk. In the one case the atmospheric fluid will leap through the air to the points of the plates attached to the ground-wire, and in the other burn its way through the paper or silk. All devices for this purpose must be carefully watched, as the passage of electricity through them will often melt a portion of the metal and establish a ground-connection, which will prevent the working of the line until removed.

In this connection, though not really part of the equipment of a line, it may be well to describe the manner of making ground-wires or connections. At stations where main batteries are to be kept, a good ground-connection is absolutely necessary to the successful working of the line, and should be made carefully. The ground-wire should be of copper, and should be equal in conducting capacity to all the wires which are to be worked from the battery, or rather should equal the conducting power or capacity of the battery itself. It may be connected by soldering to the water or gas-pipes of a city or town; but if none such exist or are convenient, it should terminate in a copper plate having six or eight square feet of surface, and buried in moist earth, below the reach of frost or drought. If the copper wire or plate cannot be had, iron wire and a plate of zinc may be substituted, or an iron wire may be led to and connected with a body of charcoal, or other form of carbon, buried as prescribed for the copper plate; but all such substitutes must be watched, especially the iron wire where it enters the earth, it being particularly liable at that point to oxidation.

## CHAPTER IV.

The labor necessary to build a line depends, of course, on the country in which it is to be built, the time allowed in which to build it, and, in short, the circumstances of each case, and much must be left to the discretion of the officer or person in charge. But a few suggestions may not be out of place; and first, the order in which the different portions of the work should be carried on. When a line is to be built and the route determined, a party or parties of not less than ten men, each in charge of a non-commissioned officer or foreman, initiate the work by digging the post-holes, the officer or foreman determining the places for the holes and seeing that they are properly made; the men working by twos, equipped with diggers and long-handled shovels, or such other tools as the nature of the soil permits. Each of these parties should be accompanied by one or two ax-men, to clear the way for the line by cutting shrubs and trimming or felling such trees as would obstruct or impede the work of erecting the line, or impair its insulation by contact after its erection. Such a party should dig holes for four or five miles of line daily, making the holes 4 feet deep and 75 yards apart. This estimate supposes clay or loam in which to make the holes, and is, of course, only approximate. For the subsistence of these and all other working parties proper arrangements must be made, but that is a matter which need not be entered upon here, as the same care would have to be taken of working parties at any other duty, and is simply commissary and quartermasters' work.



A party or parties to cut and prepare the poles should follow closely upon the diggers, and should be strong enough to supply poles for the line as fast as the holes are dug. No rule can be given, the number of men and amount of transportation depending entirely upon the work to be done, the distance posts have to be transported, &c. Axes are the only tools needed. Wagons can be fitted for transporting poles by removing the bed or box and substituting a long reach for the ordinary

Fig. 20.

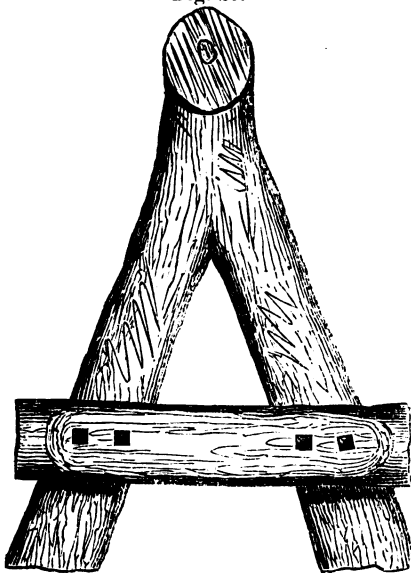

one. If the ground be impracticable for wagons, posts may be hauled two or three at a time upon a contrivance shown at Fig. 20, which can be made on the ground by any handy man. When the holes have been dug and the posts delivered for, say, ten miles, the insulators should follow and be attached, one man, or two, if more than one wire is to be put up, doing the work of

attaching them, and the party which is to erect the posts should follow closely the insulators, erecting the poles as soon as the insulation is attached, in order that they may be out of the way of such accidents as would injure or destroy them if left upon the ground.

The number of men necessary in these parties will depend upon the size and weight of the poles, but cannot be less than five men and a foreman, and only so few when the poles are of very light wood, white cedar, for instance, and well seasoned. For green posts, of oak, locust, or chestnut, ten men will be needed. In working, the foreman or a man places the foot-plate in the hole on the side opposite to that on which the post lies; the men, seizing the post with their hands, raise its top from the ground breast-high and thrust its foot against the foot-plate; the man whose duty it is places the shears so as to support the post in that position, when the men quit their hold, and, taking their pikes, arrange themselves on opposite sides of the post, and, using their pikes, at once raise the post, which slips into the hole. This releases the foot-plate, which is removed; the cant-hook is applied and the post turned, if necessary, to the proper position, *i. e.*, with the insulator on the side next the road, or the cross-arm (if any) at right angles thereto. Two men with shovels and tamping-bars fill the hole with earth and ram it solid; then the post is ready for the wire. In this, as, in fact, in all parts of the work, no pains should be spared to make the work thorough. The foreman must see that the posts are perpendicular; that the insulation is properly attached and in proper position when the posts are erected; that the holes are filled and the earth well rammed, and the surface of earth in contact with the post higher than that surrounding it, so as to turn water away from it.

The wire-party should consist of foreman and six men, with a wagon (or on railway a truck) to carry the wire and wire-reel. The wire being in the wagon and the reel in place, the wire-man places a coil upon the reel,

cuts the tie-wires, passes the end (taking care that it be the outside end) of the wire to the follower, who attaches it to the first post or such other starting-point as may be designated, the driver starts his team and the wire is drawn from the reel, the wire-man applying so much friction to the wire or reel (by a clutch or brake) as may serve to give the wire proper tension; the follower, at from 30 to 40 yards in the rear, carries the wire to the foot of the pole, and the climbers, four in number, carry the wire to the top of the post and attach it to the insulator, each man taking the fourth post from the one with which he starts. If more than one wire is to be put up, such a party will be needed for each wire, and the first party will put its wire on the insulator farthest from the route, that is, on the end of the cross-arm away from the road, or the insulator on or nearest the top of the post, so that the work of the first party shall not be in the way of the second. The foreman must see that the wire is delivered with only so much slack as is necessary, and does not hang too low when put up, that the joints or connections are properly made, and generally that the work is well and promptly performed. In putting up two wires on one line, the two parties can be kept within one-fourth of a mile of each other, and under the charge of the same foreman or officer.

Connections, joints, or splices, variously so called, may be made in any manner which will give a contact equal in area to a cross-section of the conducting-wire, so that the conductivity of the line shall not be less at that point than where the wire is continuous. The connection in common use is shown at Fig. 21, and is made by bending the ends of the two lengths to be connected at right

angles, and then wrapping each end snugly around the other wire in a close spiral makes this joint. Another

Fig. 21.

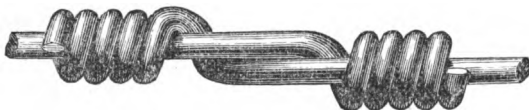

form that has been a favorite with some constructors is made by winding the ends of the two lengths around each other in long spirals which interlock. A third, used in England and the provinces, and called the "Britannia joint," is shown at Fig. 22, and no description is neces-

Fig. 22.

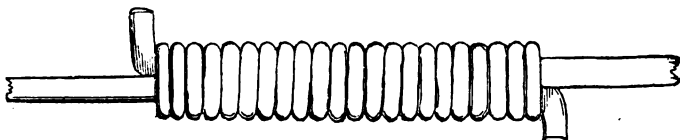

sary. The joint first shown is, all things considered, the best for military telegraphs. The wire of a joint should always be cleaned, and, when practicable, the joint soldered.

## CHAPTER V.

The line being erected, the maintenance thereof must be at once cared for, and the force necessary for this purpose must be determined by the circumstances of the case. No rule can, therefore, be given. Repairmen or patrols must be located at an office, in order that their operations may be directed by the officer or person in charge from any point where he may be, must be mounted, or provided with other means of rapid transportation, and be equipped with hatchet, insulators, pulleys, and rope, or other device for bringing together the ends of a broken wire, climbers, file, pliers, and a small quantity of line-wire. Immediately upon the discovery of a fault, the repairman on either side of its supposed location should proceed at once in its direction, and go until he finds and repairs it or meets the man from the opposite side of the fault. In addition to this duty, repairmen should have charge of a certain length of line, and should go over it often, replacing broken insulators, if any, trimming away branches of trees, shrubs, or climbing vines, (in short, preserving the wire from any contact except with insulators,) and generally maintaining the line in good condition. On long lines this work should be under the care of a chief, who should be an operator capable of working and testing a line, who should be held responsible for the proper condition of the line at all times and be required to make proper reports of all work done under his direction.

The working of a line should be the duty of a superintendent, with as many assistants as there may be circuits in the line, if more than one, and as many operators as

the business to be transmitted renders necessary. At offices that are to be kept open during the day only, and where a small amount of business is to be transacted, a single operator only is needed; but where the labor is continuous, eight hours a day is as much as a man can do and do well, and this should be broken into two watches or tours. Such lines will necessarily be worked by some of the usual modes, and are treated of as worked on the Morse plan, as the most flexible, requiring the least machinery and equipment, and the skilled labor for which the most easily procurable.

The superintendent is of course responsible for the working and maintenance of the whole, each assistant to him for so much thereof as shall be his charge, and the manager of each office to his immediate superior for his office and subordinates. A system of reports should show monthly the state of the line, condition, property received, expended, and on hand, labor employed, rate paid, work done, and, if money received, its amount, from what sources, how disposed of, and such other information as may be necessary or desirable.

Where military operations are carried on along a line of railway, telegraphs will always be needed to facilitate the operation of the railway as well as to maintain communication between the force and its base, and to render the service effectual a single officer should have control of the movement of trains and charge of the railway wires, if practicable.

On military lines, the communications of the commander, or those addressed to him on military business, must have precedence over all others, those of subordinate officers next, and private or ordinary communications, if transmitted at all, must go only when the line

is not otherwise occupied, and should be subjected to rigid scrutiny, to prevent the transmission of intelligence of an improper character. When a railway is used, and no wire is set apart for its exclusive use, the messages of the master of trains or transportation concerning the business of his office, affecting, as they do, the movement or supply of the Army, are of great importance, and take precedence of all except those of the commander of the forces.

The alphabet or code to be used on these lines may be that hereafter described ; but as the amount of business to be transacted will always be large, it may be necessary to employ skilled Morse telegraphers, and use that code. For information concerning it, and the best method of acquiring skill in its use, the student is referred to the work so often referred to already, the *Modern Practice of the Electric Telegraph*, by F. L. Pope ; to *Wood's Plan of Telegraphic Instruction*, and *Smith's Manual of Telegraphy*.

---

---

PART II.

FIELD-LINES.

---

---

4 M T





## CHAPTER VI.

The materials for a line of field-telegraph (by which is meant a line to be used in the presence of an enemy, and for the purpose of placing the commanding officer of a force in constant communication with all parts of his line) differ from those for permanent lines chiefly in point of size and capability of being quickly erected and put into use, and as quickly removed when the occasion for the line no longer exists. These materials must be, therefore, such as can be transported with the troops, handled by enlisted men, and, when in line, worked by enlisted men or officers.

The supports for a field line may be either natural, such as trees, or artificial, poles or lances. The use of the former should be guided by the same rules as for permanent lines, the circumstances being the same. The artificial supports must be of such size and weight as may be transported, and at the same time have length sufficient to carry the wire above the reach of mounted men or wagons, and strength enough to endure such handling as under the circumstances they would be likely to receive, as well as to bear the weight and strain of the line-wire. To meet these requirements they must be made of a material at once light and elastic, and the timber best adapted seems to be spruce or cypress, either of which, when well seasoned, fulfills very nearly these conditions. The size may vary within certain limits, but that adopted in the field-telegraph trains of the United States Army is 17 feet long,  $2\frac{1}{2}$  inches diameter at the butt, and  $1\frac{1}{2}$  inches diameter at top, the butt tapering to a blunt point and the top secured by a sheet-iron ferrule 3 inches in length. Such

a lance, of cypress, weighs about eleven pounds, and of spruce a trifle less, and two hundred and fifty of them, together with insulation for ten miles of wire and tools for the erection of a line of that length, can be carried on a truck made for the purpose, and readily handled by six mules or four horses. A field-line should be supported by forty such lances to each mile of wire, but in emergency, or upon favorable ground, this number may be reduced to thirty-five or even to thirty without serious difficulty resulting.

In the matter of insulators for field-lines there is small room for choice. Glass and porcelain, the substances in common use for permanent lines, are unfit because of their fragility; the common resins, paraffine, &c., are unfit because of the difficulty of applying them, and there remain only the gums, caoutchouc, gutta-percha, and ballata. Of these gutta-percha becomes friable when long exposed to the sun, rain, and wind, and in such condition loses its good qualities; its use, therefore, is precluded. Ballata is not well proven, and no preparation thereof is yet offered which has consistence enough for the purpose. Caoutchouc when raw becomes viscid and loses form under summer temperatures, but, in the prepared form known as vulcanite, ebonite, or, more familiarly, "bone-rubber," resists any heat less than that of boiling water, and has strength and consistence enough for the purpose, at the same time retaining to a great degree the non-conducting power of the raw or unmanufactured gum, making it the most desirable material for insulators for this service.

The form of the insulator is a matter of choice, two conditions only being of importance—that the outer surface shall shed rain, and that there shall be an inner

surface which shall remain dry, in order that there shall be between the wire of the line and the lance (which, when wetted by rain, becomes a partial conductor) a non-conducting surface. This can be obtained only by protecting a part of the surface of the ebonite from moisture, which, if allowed to reach it, forms a film over its surface and acts as a conductor. The formation of this film may be at least partially prevented by occasionally dipping the ebonite insulator into melted paraffine, the coating of that substance which the ebonite receives acting to prevent the formation of a continuous film of moisture, breaking the water into drops, at the same time that it preserves the surface of the ebonite from "weathering," and so acquiring a spongy character favorable to the formation of the water-film.

Various forms or patterns have been used, one of which was a simple cap of flexible vulcanite to fit over the top of the lance, both lance and cap having a cleft in which the wire rested, and was secured by being wound around the outside of the cap; another, which consisted of a wire suspender or "clamp" of ebonite armed with a gimlet-pointed screw, by which it was affixed to the lance or other support; another consists of a spike, which passes through the top of the lance, or is driven into a tree, and a suspender formed in part of ebonite. Each has merit, but neither gives entire satisfaction. It would seem evident that the fewer parts the insulator consists of, the better, as less liable to become useless by fracture; that the insulator should be readily attached to and detached from the lances or other supports, and that the device for grasping the wire should be such that the wire could be easily placed therein and not readily displaced, and be held without bending.

Substitutes for any regular form of insulator can be made from many materials, and the ingenuity of the officer must be his reliance. The non-conducting properties of bodies being known, he must make use of the best within his reach, and turn it to such advantage as he may. An insulator of "fat pine," or any wood saturated with resin, may be made to answer a good purpose while the saturation continues. Loops of cotton, linen, or silk fabric suspending the line-wire will insulate it sufficiently during dry weather, and, if saturated with oil, will prove efficient on a short line even in rain or fog. Saturation with paraffine would be more effective than with oil, and a quantity of this substance might be comprised in the list of supplies for a field-train with much propriety. Wire for field-telegraphs must be light, flexible, and strong enough to bear a tension which will reduce the deflection or "sag" between lances 70 yards apart of 2 feet. Iron is the only material which answers the purpose at moderate cost, and an iron wire, drawn from charcoal rods to No. 15 American gauge, has been adopted for use by the United States. A mile of this wire, joined up and the joints soldered, makes a coil 18 inches in diameter inside, 4 inches in height, and 3 in thickness, and weighing but 75 pounds. The American compound telegraph wire, a patented article, consists of a steel core, with a coating of copper, and, when drawn to No. 18 size, has, when new, equal strength and greater conducting capacity than No. 15 iron wire, but is not well adapted for field use, being less flexible than the iron, breaking more easily if bent, and deteriorating rapidly in consequence of the oxidation of the steel core, wherever moisture reaches it, which it can scarcely fail to do, as the copper

coating or envelope opens to the steel whenever the wire is rudely bent or handled.

For use where, for any reason, it is impracticable or inexpedient to erect a line upon supports, and therefore necessary to lay it along the ground, conducting-wire must be provided which is insulated throughout its entire length. Such a wire has been referred to heretofore as "office-wire," but especial pains need be taken to provide for field use, and the various descriptions of such insulated conductors, their characteristics, method of manufacture, strength, flexibility, and conducting capacity understood. Copper, from its high conductivity, is the metal used, and is strengthened in various ways. One device is to form a conducting strand of five wires, the center one of steel, for strength, and the other ones, laid spirally around the center, of copper. Such a strand, made of No. 30 wire, will have the strength of a No. 14 iron wire and the conducting capacity of No. 8, or very nearly, and may be insulated in any manner, like a single wire. Kerite, a preparation of caoutchouc, not yet well known or proved by use, has shown valuable qualities under experimental tests, resisting the action of the atmosphere, which usually destroys such preparations, and is highly recommended by many competent telegraphers and electricians. A single copper wire, covered with a layer of hemp fibers laid parallel to it, and the whole with a spiral covering of cotton, (cotton and hemp being saturated with paraffine,) is light, quite strong, (sufficiently so to sustain itself in spans 200 to 300 feet long,) and sufficiently well insulated for ordinary use. The insulation can be kept up by occasionally passing the wire through a bath of melted paraffine. Another device for retaining the hemp

fibres in place has been used by some manufacturers, viz, braiding flax around it ; and a preparation of paraffine and coal-tar, known as "Bishop's compound," is used instead of the pure paraffine. For use under water, gutta-percha is the best insulating material known, improving when submerged, instead of deteriorating. For subterranean use the same can be said.

## CHAPTER VII.

Instruments for field-lines must be simple, easily placed in position for use or removal, easily adjusted, and strong. Several varieties have been tested by the

Fig 23.

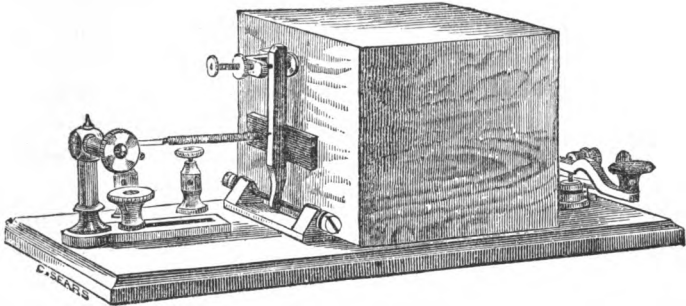

Signal-Office, but the one from which the best results have been obtained is a form manufactured by Messrs. L. G. Tillotson & Company, in New York, and known

Fig. 24.

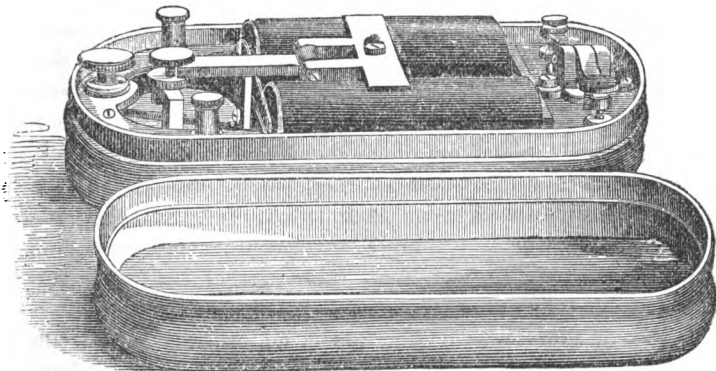

as the "box sounder," shown in Fig. 23. Another form, known as the Caton instrument, shown in Fig 24, con-



sists merely of an electro-magnet, mounted horizontally and provided with an armature, the vibrations of which, when attracted to the poles of the magnet or withdrawn therefrom by the tension-spring, give the sounds by which the signals are recognized; a key, by which the circuit is opened and closed in signaling; a device by which the circuit is kept closed, except when the key is in use, and screw-posts, by which to attach the line-wires; the whole contained in a case to protect it during transportation. The one shown in the cut is of convenient size, being about 6 inches long and  $2\frac{1}{2}$  in width and length.

Batteries for field use need not be so powerful as for permanent lines, and others which require the use of such powerful excitants as sulphuric and nitric acids, and must not be composed of glass or other fragile material. These conditions render the Grove and Bunsen batteries unsuitable, and leave the Daniells only for use in some one of its various modifications. The form used at present by the United States Signal-Service is an adaptation of the Daniells, and consists of a wooden trough, divided into cells by wooden partitions, the whole being rendered non-conducting and impervious to water by saturation with paraffine; a thin copper plate, near the bottom of each cell, having underneath it a layer one-fourth of an inch thick, and above it a layer three-fourths of an inch thick, of crystals of sulphate of copper; a sponge, saturated with water and filling the cell to within an inch of the top, upon the upper surface of which is sprinkled white vitriol, (sulphate of zinc,) and a zinc plate, which rests upon the sponge. The cells are 5 inches square, being the same in length, breadth, and depth; the top, bottom, and

sides of the box or trough containing them, 1 inch, and the partitions between the cells one-fourth of an inch in thickness. The copper plates are  $4\frac{3}{4}$  inches square, and about one-sixteenth of an inch in thickness, and to each one is attached a copper wire, insulated with gutta-percha or caoutchouc, of sufficient length to reach the zinc of the adjoining cell. The zinc plates are  $4\frac{1}{2}$  inches square and 1 inch in thickness, and are furnished with thumb-screws for connecting the wire from the copper element of the next cell. The cover of the box or trough is hinged, and when closed is secured by hasps and staples.

Fig. 25.

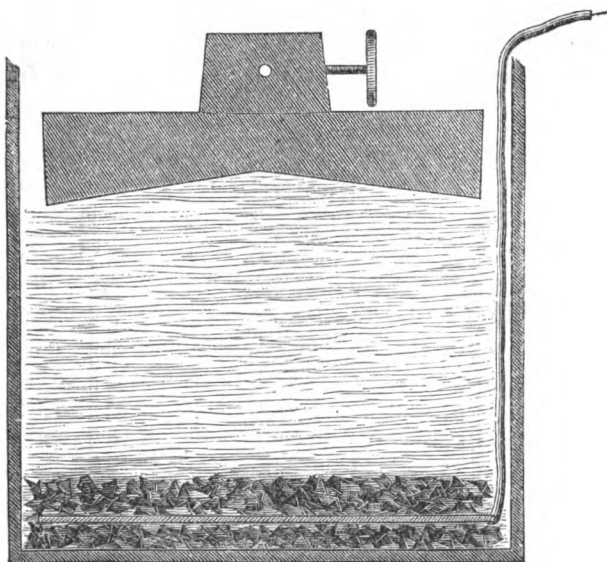

When closed and secured it presses firmly upon the zinc plates and prevents any displacement of the parts of the battery. It will be seen that this is substantially the

Daniells copper-zinc pair, the sponge taking the place of the porous earthen cup, and the trough or box, that of the glass or earthenware containing-vessel. The superposition of the zinc prevents the copper solution from reaching it, and the battery so arranged works with little diminution of force as long as any of the crystals of blue vitriol remain undissolved. It is only necessary to add a little pure water from time to time, to supply the waste by evaporation or leakage. When the cell is filled 1 inch in depth with the crystals, it will work from forty to sixty days without renewal. When necessary to renew the battery, the materials must be removed, the sponges well cleaned, and the whole replaced in proper position. The form of cell and arrangement of the different parts will be understood from Fig. 25.

Fig. 26.

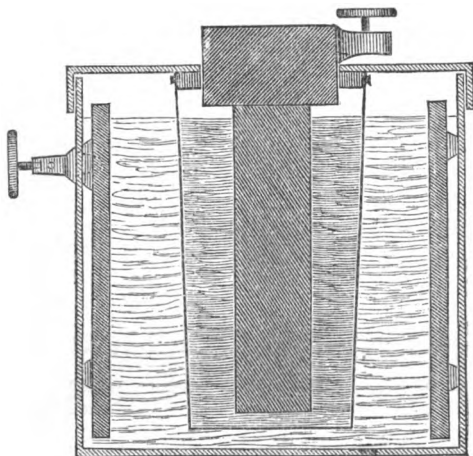

Fig. 26 shows an adaptation of the "Marie Davy" cell to field use. The containing-vessel is of ebonite

and the cover screws on water-tight. The zinc is kept in place by studs that fit closely into the containing-cell, and into one of which a screw-post passes from the outside. The porous cup is of leather, and is fastened to the cover. The negative element is carbon, a plug of which is fitted with a metallic head that screws into the cover within the porous cup. This cell is charged by filling the porous cup with a paste of the bisulphate of mercury and water, and the outer cell with the water in which the paste was made. The action is similar to that of the copper-zinc pair, the oxygen of the water attacking the zinc and the freed hydrogen finding its office in reducing the mercury from its crystalline salt. It gives off no gas and works as long as any of the salt remains in the porous cup.

In the absence of any form of battery especially adapted for field use, any of those described herein can of course be used, and the ingenuity of the officer must be his reliance. The principal difficulty will be found in providing transportation for them, and this must be overcome in the best possible manner. The signal-service battery can be made roughly under almost any circumstances—out of a feed-trough by putting in partitions and coating the inside with wax, tallow, pitch, or other non-conductor; out of a number of buckets, or, in brief, any vessel that will hold the elements. Cotton, tow, sawdust, spent tan-bark, sand, or almost any porous substance may be substituted for the sponge, and the battery be made to answer a good purpose until others can be procured. The white vitriol is not indispensable, as the battery will work without it, only requiring a few hours' time to come to its full strength.

The ground-connections for a field-line are necessarily such as can be quickly made and easily removed. The

most convenient form is that of a cylindrical iron bar, 5 feet long and 1 inch in diameter, pointed at one end and fitted at the other with a binding-screw, by which to attach the ground-wire, the whole zinc-coated, (galvanized,) to prevent oxidation and to present always a bright surface to the earth. Such a bar, driven two-thirds of its length into moist earth, is a sufficient ground-connection for field-lines of thirty miles in length.

In cases where the earth at the station is so dry as to render the bar ineffectual, moist earth must be sought at a distance and the ground-wire run to it, or the earth moistened by pouring water into the hole made by the bar, the first-named method being preferable, for the reason that the moisture in the second case will scarcely be carried far enough to remedy the defect.

Ground-connections may be made as for permanent lines whenever circumstances (loss of bars, &c.) may render it necessary or convenient to do so. The rule to be followed is the same in one case as in the other—a surface in contact with earth that shall equal in conductivity the battery and line.

The tools for the erection of a field-line (which constitute, with the materials for the line, the outfit of the train) are: marking-pins, by which the points of support are indicated; axes and hatchets, to cut away shrubs or branches of trees, or to affix insulators to natural supports; crow-bars, to make holes in the earth in which to set the lances; bars, fitted for cutting through frozen ground; climbers, to enable the men engaged in the work to ascend trees, when necessary, for the purpose of affixing insulators thereto or to trim away branches; reels, for the delivery and recovery (uncoiling and recoiling) of the wire; pliers, to be used in making connections; files and screw connectors, which are to be used

for making connections between the coils (mile lengths) of wire in reeling out, and generally, where connections are to be frequently made and broken, to avoid loss of time and waste of wire.

The marking-pins are of iron wire, one-eighth inch in diameter and 15 inches long, pointed at one end and having a loop or handle at the other, painted of some bright color, and fitted with a small pennon of bright-colored cloth, so as to be conspicuous objects, and are used to mark the places where lances are to be erected by being thrust into the earth at such points, or the natural supports to which insulators should be affixed by the same methods.

It is scarcely necessary to describe axes or hatchets, except, perhaps, to say that the latter should have a hammer-poll with which to drive a spike. But the efficiency of the line may depend on their use, which is mainly to cut down all shrubs growing near the line-wire, to trim off such as come, or might be thrown by the wind, in contact with the line-wire.

Crow-bars, with which to make seats for the lances, are cylindrical iron bars,  $4\frac{1}{2}$  feet long,  $1\frac{1}{4}$  inches in diameter for 2 feet from the point, and 1 inch in diameter for the rest of their length, and pointed so as to penetrate the earth easily. Such a bar weighs 15 pounds. These (and all the iron used in the work) should be zinc-coated, (galvanized.)

Ice-bars are of the same general form and dimensions as the crow-bars, but have a wide, chisel-shaped point or blade, and are used for cutting through frozen ground, to facilitate the work of setting the lances.

Climbers, to enable the men engaged in erecting a line to ascend trees to affix insulators and attach the wire,

are of various patterns. A good form is made of steel, with leathern straps for attaching them to the feet, and weigh about 4 pounds the pair. The strap or sling is carried over the shoulder of the man, and used to aid him in maintaining his position without the use of his hands, leaving them free for the work of handling his tools.

Reels for field use are in general form like those for permanent lines, but are lighter, and are provided with arms attached to the uprights, which are laid flush with the face of the uprights when reeling out wire, and secured at right angles thereto when reeling up, in order to confine the wire and give the coil its proper shape. Each one has a handle affixed to the extremity of one of the upper cross-arms, by which it is turned when reeling up wire.

The reel is seated in the wire-wagon, but may be carried by men over ground impracticable for the wagons in the hand-bearer, one of which should accompany each reel.

Pliers and files are of the same kind as for permanent lines, but smaller, as the wire is smaller and the work to be done lighter. Connectors are simply brass cylinders, perforated through their length to admit the wires, and fitted with a thumb-screw, the end of which presses upon and holds the wires so inserted.

## CHAPTER VIII.

The vehicles used for the transportation of the materials, tools, and equipments are also used for offices or stations, and are called battery-wagons, wire-wagons, and lance-trucks.

The battery-wagon is the central or headquarters office; is of a size sufficient to contain four instrument-tables, the necessary batteries for four lines, each ten miles in length, instruments and table-apparatus for each table, four ground-bars, a supply of battery-material, seats for four operators, and a stove.

It is mounted on platform-springs, and turns in its own length, is covered with canvas, and must not be too heavy to be drawn by two horses over any ground practicable for artillery. The tables are each  $2\frac{1}{2}$  feet long by 1 foot or 1 foot 3 inches wide, are attached to the sides of the wagon at a height from the floor of  $2\frac{1}{2}$  feet, one in each corner of the wagon. The batteries, in sections or cases of six cells, are supported by brackets underneath the tables, each bracket being of a size sufficient to support two such sections. The instruments and table-apparatus are carried, when not in use, in pouches of leather attached to the sides of the wagon between the tables, the supply of battery-material in a box underneath the driver's seat, the ground-bars on the floor, next the sides, (two on each side,) and confined by clamps and keys; and the seats for the operators (camp-stools) in any convenient manner. The stove is placed in the center of the floor and secured against displacement. The wagon is entered by a door at the rear.

The wire-wagon is of the same general form as the battery-wagon and mounted in the same manner. It is



of good size and strength to contain an instrument-table, which is attached to the front end, a single section of battery underneath the table, a pouch for instrument and apparatus at its side, a seat (camp-stool) for the operator, a ground-bar secured as in the battery-wagon, a wire-reel, seated in a socket in the center of the floor, near the hind end; a hand-bearer, secured at the top of the wagon by straps; ten coils of wire, (one mile in each,) secured, for transportation, at the sides of the wagon; and a box, which serves to hold the wireman's tools (pliers, files, and connectors) and as a seat for him when at work reeling out or recovering wire. This wagon must be strong to safely carry its load, but must, at the same time, be light enough to be handled by two horses on roads or ordinary ground, and by four over any ground at all practicable for wagons.

The lance-truck is a wagon without springs, of length sufficient to carry lances, and of strength sufficient to sustain the weight of 250 lances and all the line-tools and insulators for ten miles of line. The lances are stowed compactly in the middle of the wagon or truck and confined by upright stanchions and end-boards. The insulators and tools are contained in boxes arranged for the purpose on either side of the pile of lances. The weight of the load will be approximately 3,000 pounds, and a good six-mule team will be needed to move it. It carries 250 lances, 400 insulators, 16 crow-bars, 4 ice-bars, 2 axes, 12 hatchets, 12 pairs of climbers, and 80 or more marking-pins.

A full train consists of one battery-wagon, four wire-wagons, and four lance-trucks, and is divided into four sections, each of which consists of a wire-wagon and lance-truck, and is capable of acting independently.

Thus a full train may erect lines radiating in four directions from the battery-wagon, or the four sections, the second commencing to reel out its wire when the first has finished, may extend a single line forty miles long, having offices at the termini and at three intermediate points equidistant from each other. Additional instruments being furnished, intermediate offices, other than the regular ones, can be opened whenever necessary.

The train is commanded by a chief of train, whose place is with or near the headquarters of the force with which the train is acting, and with him the battery-wagon with its complement of operators, battery-man, and driver. To work the four lines separately twelve operators will be the ordinary number, three for each of the lines, giving to each eight hours' duty out of each twenty-four; and this should be divided into two tours, or watches, of four hours each. Should the work to be done by the lines be exceedingly heavy, this force might be increased to advantage, and under other circumstances might perhaps be reduced; but it is false economy to require too much of men, and eight hours of close attention is fully enough. The battery-man will have charge of and be held responsible for the batteries, not only those in the battery-wagon, but also those in the wire-wagons, will see that they are at all times in order and ready for work, have the care of the supplies for them, and make regular reports to the chief of train, embracing all necessary information concerning them.

Each section will be commanded by a chief of section and manned by four non-commissioned officers and thirty-six men, whose several duties will be:

One director, (non-commissioned officer,) who, receiving from the chief of section general orders concerning

the direction to be taken or point to be reached, will go over the ground and select the route for the line. He will be accompanied by two markers, carrying guidons, whom he will station so as to guide the surveyor. The director should be carefully selected, as upon his skill and judgment depends, in a great degree, the promptness with which lines can be erected. He must take the most direct line practicable to the point he has to reach, but, in order to determine what is best, he must examine the character of the ground and know that there are no obstacles insuperable to the train—streams, ravines, bluffs, or marshes; that the soil is such that the line can be erected—not loose sand or rocks; that the route he selects is not made impracticable by the guns of an enemy; and, in short, must bear in mind all the contingencies to which the train or line may be subjected, and be governed by the circumstances of the case. The director and markers must be mounted, and each marker, on being relieved from post by the arrival of the surveyor, will rejoin the director. Over difficult ground it may be necessary to increase the number of markers, and upon a road or over country well known it may be practicable to dispense with them entirely, the director accompanying or slightly preceding the surveyor. For night-work the markers will carry a lantern instead of a guidon.

One surveyor, whose duty it is to move toward the marker in sight, measuring the distance by paces, and directing the pin-men where to plant the marking-pins. He will be governed by the general rules for locating lines, as laid down herein, in which he should be thoroughly instructed. He is accompanied by three

pin-men, two of whom have each forty or more marking-pins, which they plant at points indicated by the surveyor, to indicate the place where lances are to be erected or insulators attached, if natural supports are used. The first man, when his pins are expended, halts until the third, who follows the lance-men, has gathered the pins and overtaken him, when he rejoins the surveyor, and the second, on expending his pins, does the same, the first and second relieving each other and the third bringing up the pins when the line is erected.

Thirteen bar-men, twelve of whom are equipped with a crow-bar, with which, at the points indicated by the marking-pins, they make holes for the foot of the lance. This must be carefully done, and, that it is so, it is the duty of the thirteenth, who is a non-commissioned officer and chief of the detachment, to see. The holes must be fully 2 feet deep, which will be the case if the shoulder of the bar is below the surface when the point is at the bottom of the hole, and large enough to admit the lance easily. As the lance is of twice the diameter of the bar, the hole must be made of the proper size by working the bar around and pressing back the earth, and this should be done as the bar is driven down, for, if the bar be driven first to the full depth and then worked, it will be difficult to sufficiently enlarge the hole in ordinary soils, and, when done, will not be of uniform size, but large at the top and bottom, and smaller midway, a point to be avoided, as in such a hole the lance will be easily drawn from a perpendicular, even if it can be forced to the bottom. The bar-man, standing erect, should grasp his bar near the top with both hands and drive it into the ground, working with hands close together, as, if he grasps the bar with one hand

near the top, and the other below, he will not work as easily or direct the blows of the bar so accurately, but will be compelled to bend his body sidewise, his upper hand will throw the top of the bar from him and the lower hand draw the point toward him; the work will be done in a slovenly manner, and the hole, when completed, not be perpendicular.

Two wire-men, whose duties are to accompany the wire-wagon and attend to the reeling out and reeling up of the wire. They will, in reeling out, place the coils of wire upon the reel, remove the straps or wires by which it is bound, and one of them, seated in the wagon, by the use of the brake so control the motion of the reel that the wire shall be laid straight and without slack, and will make the necessary connections as the coils are one after another paid out. Joints in field-wire should be made in the same manner as in wire for permanent lines, except that, to join the end of one coil to that of another, it is well to use a wire-connector, as these joints mark off the line into mile lengths for convenience in recovering the line and recoiling the wire, and time is saved by their use. All joints other than these must be carefully made in the same manner as for permanent lines and soldered. The second man will follow the wagon and carry the wire to the line of lances, and render such assistance to the first as may be required.

Thirteen lance-men (one of the number being a non-commissioned officer and chief of the detachment) will affix the insulators to the lances and deliver a lance and insulator at each hole, one or two men being mounted upon the lance-truck for that purpose, and the others will place the wire in the insulators, erect the

lance, thrust its foot into the hole prepared for it by the bar-men, and stamp the earth solidly around it.

Three operators, to work the station when opened, and drivers for the wire-wagon and lance-truck complete the force.

## CHAPTER IX.

### TRAIN DRILL—(ONE SECTION.)

The minimum force for illustrative drills with a section-train is as follows: One (1) lieutenant, one (1) director, one (1) surveyor, two (2) pin-men, seven (7) bar-men, two (2) wire-men, seven (7) lance-men, two (2) operators, and three (3) drivers.

It will be parked in the following order :

Wire-wagon in line with and ten (10) paces on the left of the battery-wagon, and the lance-truck in rear of the center of the wagons, with distance of ten (10) paces, as indicated in Fig. 27.

At the "first call," the drivers, director, and markers will saddle and harness up.

When the "assembly" is sounded, the drivers will lead out and hitch up, the director and markers will lead out and take position immediately in front of the train, and with the drivers will stand at "attention" and "dismounted." The drivers, when dismounted, will always stand at their horses' heads.

The men for duty with the section will be formed on the parade in two ranks, the roll called, and the detachments told off, the latter taking position in the following order: The surveyor and pin-men on the right, the bar-men with an interval of two paces, the wire-men with an interval of two paces, the lance-men with an interval of two paces, the operators and battery-men with the same interval.

They will be marched in column of detachments to the ground where the train is parked and wheeled into line by the flank previously designated, facing the train.

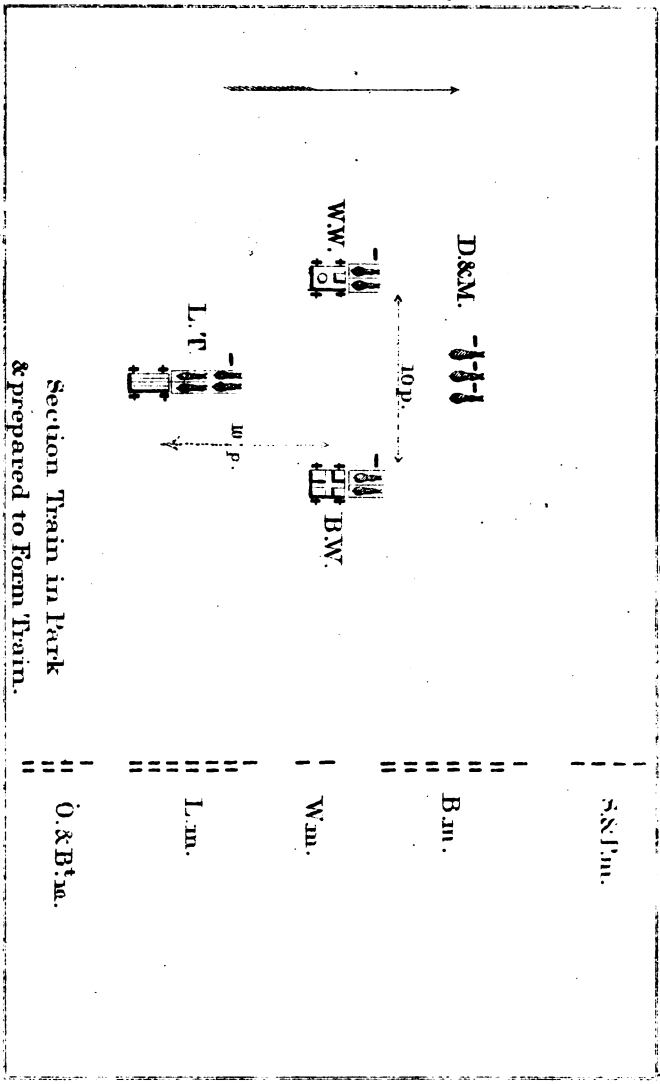

Section Train in Park  
& prepared to Form Train.







PLATE XXXIII.

D. & M.



---- S. & P. m.

===== B. m.

-- W. m.

----- L. m.

---- O. & R. m.

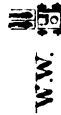

W.W.



B.W.



L.T.



20 p.

Form Train.



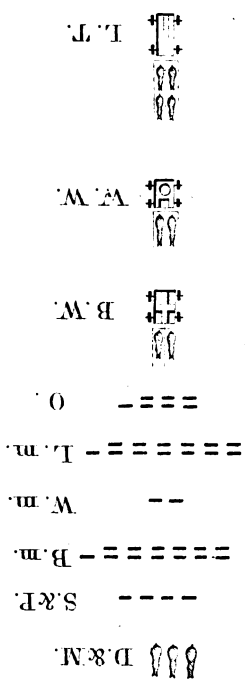

Train on the Road.

The section-train being in park, with the detachments in line near it, the chief of train, wishing to form the train in column of route, will command—

1. "Form train front, (right, left, or rear,)"
2. "March, (or double time, march.)"

*The train is always formed on the line of direction of the battery-wagon, whether the train be in disorder or in park.*

At the first command the director, markers, and drivers mount, and director and markers and battery-wagon move, if necessary, to take the direction indicated. The chiefs of detachments give the cautionary commands to cause their detachments to move toward the proposed front. At the second command the battery-wagon halts, the director and markers take post twenty (20) paces to the front of the battery-wagon. At the same command, which will be repeated by the detachment commanders, the detachments will move off and form in close column in the same relative order as before, behind the director and markers. (Fig. 28.)

The section being formed for the march, the park will be broken, and it will be moved forward by the command—

1. "Forward,"
2. "March,"

when the director and markers will move forward, followed in order by the column of detachments, the battery-wagon, the wire-wagon, and the lance-truck.

On the march the section is formed as shown in Fig. 29.

The direction and swiftness of the march will be regulated by the movements of the director and markers, under the orders of the captain.

The section being on the march, to halt it previous to opening station, the chief of section commands—

1. "Section,"

2. "Halt."

To open station, the chief of section will command—

1. "Open station, right, (or left,)"

2. "March."

At the second command, the battery-wagon will move out of the column to the point indicated, and be followed by the battery-man and three (3) operators; at the same time the wire-wagon and lance-truck will close up to the column of his detachment, the driver of the battery-wagon will unhitch his horses and stand at their heads, and the battery-man will make the necessary ground-connection. To open station, the train being in march, the command will be the same, (1. "Open station, right, (or left,)" (2. "March.") At the command "march," the detachments *halt* under command of the chiefs of detachments, the battery-wagon wheels out of the column in the direction indicated, and the wire-wagon and lance-truck close up upon the column of detachments and halt. The command will then be—

1. "Equip,"

2. "March, (or double time, march.)"

At the first command, the chiefs of detachments will cause them to face about. At the second command, which will be repeated by the chiefs of detachments, the latter will separate and move in equal divisions on either side of the train, the operators and two wire-men taking position at and to the rear of the wire-wagon, and the lance-men, bar-men, and pin-men on either side of the lance-truck, where they will take equipments, and face toward the front of the train; the lance-men opposite the rear wheels, the bar-men between the wheels, and the pin-men, and the two lance-men who are to deliver





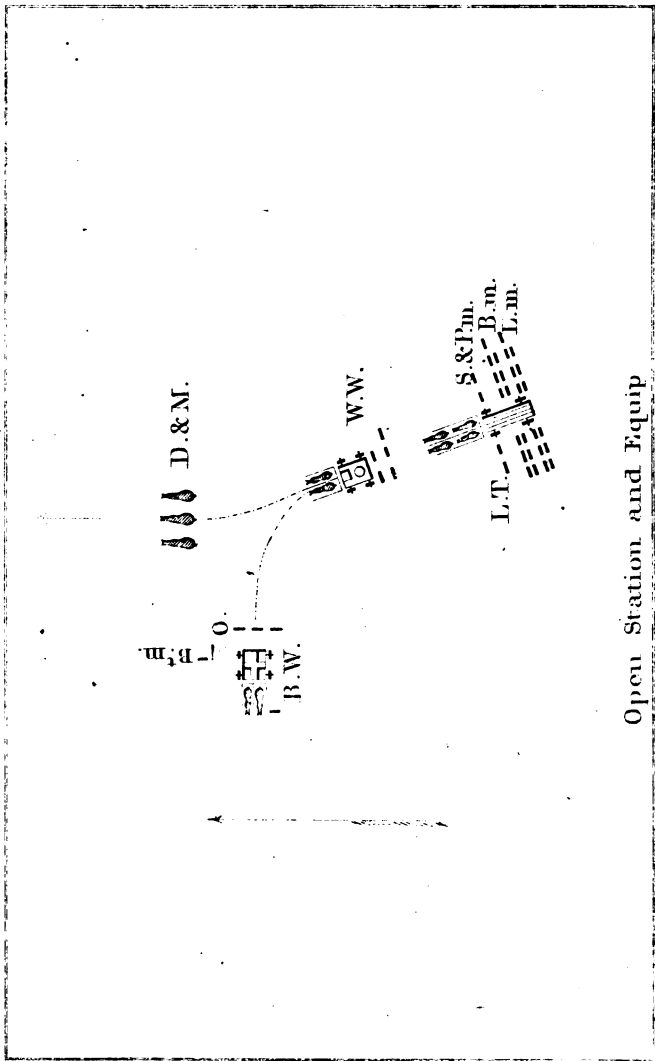

Open Station and Equip



PLATE XXXVI.

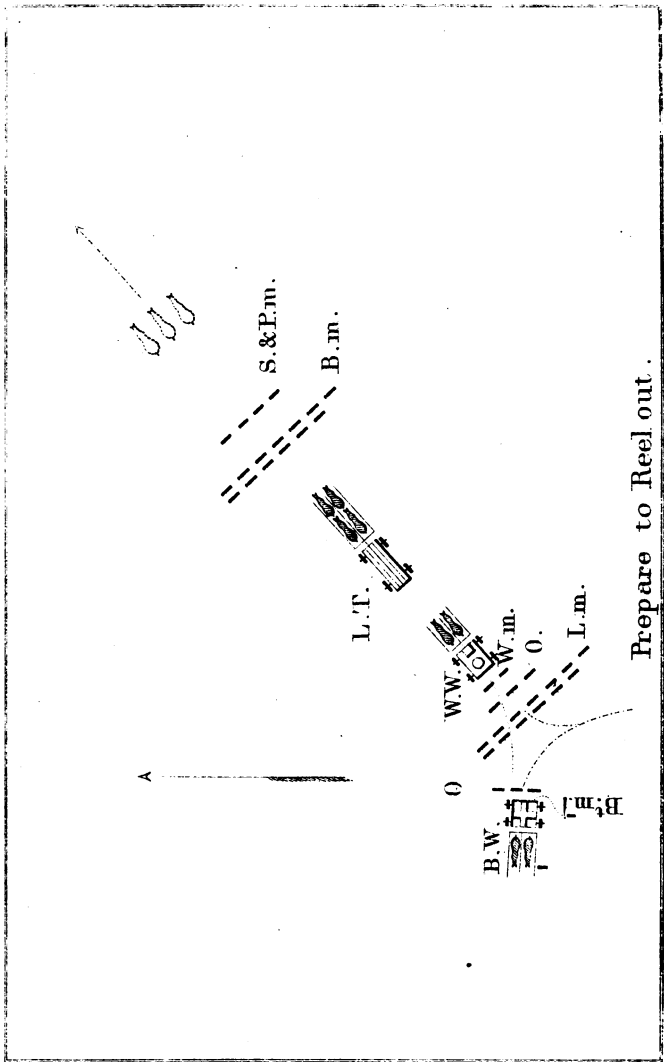

Prepare to Reel out.

lances, opposite the front wheels of the lance-truck. (Fig. 30.) The command will then be given—

1. "To your posts,"
2. "March, (or double time, march.)"

At the first command, the director and markers move forward 20 paces, the bar-men raise the bar to the right shoulder, and the two designated lance-men mount the lance-truck.

At the command "march," the surveyor and pin-men move to the front, and immediately behind the director and markers. The bar-men follow the surveyor and pin-men. At the same time the lance-truck will pass the wire-wagon and close up upon the bar-men. The lance-men are marched to the rear of the wire-wagon.

At the command—

1. "Prepare to reel out,"

the director, having been instructed by the lieutenant as to the direction and route of the line, moves forward rapidly with the markers, stationing the first marker at a point about 300 feet from the wire-wagon. One of the wire-men takes the end of the wire from the wire-wagon and makes it fast to the wheel of the battery-wagon. (Fig. 31.) The first pin-man, under direction of the surveyor, marks the first hole about 30 paces from the battery-wagon, a bar-man falls out to make it, and the first lance is delivered by it. The command is then given—

1. "Reel out,"
2. "March."

At this command, the director moves forward, taking the second marker, and stationing him at a second point on the route visible to the first maker. The distances between the makers thus placed will be necessarily

regulated by the topography of the country. The lieutenant moves forward; the surveyor follows on the line indicated by the markers, and is accompanied by two pin-men.

The first pin-man, with forty marking-pins, (for one mile of line,) follows the surveyor, who paces the distance of 55 steps, or 132 feet, the distance between poles, and indicates the points where the pin-man shall place the pins.

The second pin-man, similarly equipped, also accompanies the surveyor, and relieves the first when the pins of the latter are used up.

The third pin-man takes station at the first pin placed.

The bar-men (each with a crow-bar) follow the pin-man, making, by the side of each pin thus placed, a hole large enough to admit the foot of the lance easily, and two feet deep, the length of the bar from point to shoulder being the measure, and the hole being made, leaving the pin beside it to guide the lance-men.

The lance-truck will follow close upon the bar-men, the two lance-men in the truck attaching a spike and insulator to each lance and delivering a lance so prepared at each hole.

The wire-wagon, with operators and two wire-men, follows the lance-truck reeling out the wire; the first wire-man in the wagon in charge of reel, and the second wire-man following, carrying wire to the line of poles.

The lance-men, eleven (11) in number, follow the wire-wagon, placing the wire in the insulators and erecting the lances, taking care to force them to the bottoms of the holes, and that the insulator-spikes are at right angles to the line and the insulators properly adjusted.

The third pin-man now follows the lance-men, and as



PLATE XXXVII.



W.W.  
W.m.



O.  
S.&P.m.  
B.m.



L.T.

L.m.

Take Station.

the line is erected gathers the pins and delivers them to the pin-man, who sets them, and who waits at the point where he placed the last pin, when the latter pin-man moves in double time to the front and relieves at the proper moment the one who precedes him.

The end of the line having been reached, the command will be given—

1. "Take station, right, (or left,)"
2. "March."

At the command "march," the lance-truck halts and is passed by the wire-wagon, which moves to take the position indicated by the chief of section, when ground-connection is made by a wire-man. As they come in, the lance-men take position behind the lance-truck, and the bar-men and pin-men behind the wire-wagon. The drivers will then hitch their horses and stand at their heads. The train is now arranged as in Fig. 32.

Having thus formed, the equipments of bar-men and pin-men are returned under direction of chief of section, and such disposition made of the men as may be advisable, under his directions.

Details should then be made for patrols to guard the line and make repairs when necessary. Each man is made responsible for a certain portion of the line which is assigned to him.

To recover the line, the command is given—

1. "Close station,"
2. "March."

The wire-man removes the ground-connection, the horses are hitched to the wagons, and the drivers mount.

At the command—

1. "Prepare to reel up,"
- the wire-wagon and lance-truck wheel about on their



own ground, and then stand fast. The lance-men, bar-men, and pin-men are faced about. (Fig. 33.)

At the command—

1. "Reel up,"
2. "March,"

the lance-men, commencing at the wire-wagon, draw the lances, free the wire from the insulators, and pass the lances into the truck. The two men in the truck receive lances, detach insulators, and return parts thereof and lances to their places.

The wire-wagon, following, reels up the wire, the pin-men assisting the wire-men, and the bar-men taking care that the wire does not run into kinks or become entangled, so as to prevent it from being readily reeled up. Care should be taken that the lance-truck and wire-wagon are not more than 150 paces apart, and the lance-men not more than three lances in advance of the lance-truck.

Upon reaching the central station, and when the lance-truck reaches the first lance, the lieutenant will command—

1. "Section,"
2. "Halt."

At the command from the chief of train—

1. "Close station,"
2. "March,"

the wire-wagon reels up to the end of the line, passing the lance-truck, and moves in rear of the battery-wagon, the detachments retain their relative positions and the horses are hitched to the battery-wagon, the wire-man detaches the line from the battery-wagon, and the battery-man removes the ground-connection. (Fig. 34.)

The chief of train then commands—

PLATE XXXVIII.

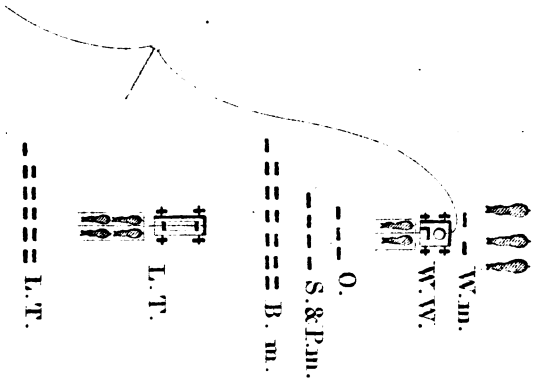

Prepare to Reel up.



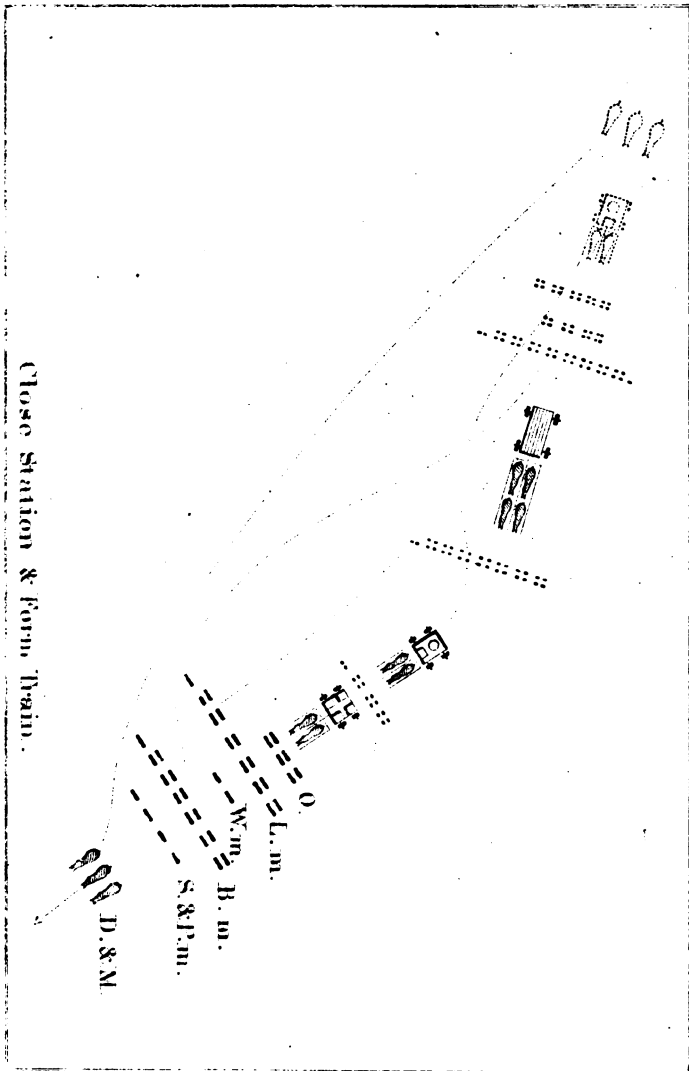

Close Station & Form Train.





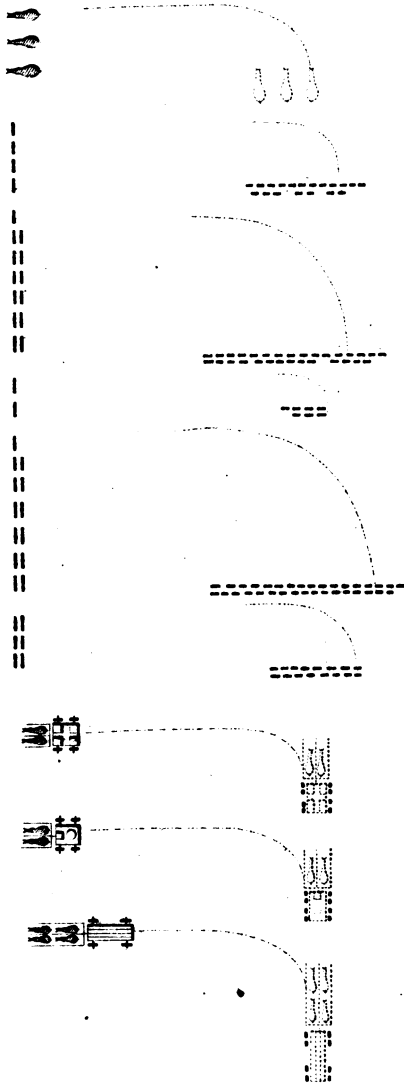

In Line Left

1. "Form train front, (right, left, or rear,)"
2. "March, (or double time, march,)"

when the detachments will be promptly placed as directed in the train formed for the march.

The command "form train front, (right, left, or rear,)" "march," may be given at any time by the chief of train when it is necessary to change his design of reeling out, &c., provided the wagons are near together.

The general rule governing the movement is that the director and markers shall move, if necessary, 20 paces in front of the battery-wagon (which is turned toward the proposed front of the train) when the command "form train" is given; then, at the command "march," the detachments take the shortest line to their places in column, in front of the battery-wagon, and the wire-wagon and lance-truck wheel as nearly into their proper places as the nature of the ground will allow, so that they may gain them at once; then the train is moved forward by the usual commands.

The train being in column *en route*, in order to move in line to the right or left, the chief of train will command—

1. "In line, right, (or left,)"
2. "March."
3. "Guide left, (or right.)"

At the first command, the chiefs of detachments caution them to wheel to the right, (or left.)

At the second command each detachment and wagon turns to the right (or left) and moves forward in line, the guide being toward the director and markers.

The drivers must be careful to preserve their intervals and keep the heads of their lead-horses dressed on the line. (Fig. 35.)



The train may be halted by the command—

1. "Train,"
2. "Halt."

The train being in line, (either at a march or halt,) it may be formed in order of column to the right or left and moved forward by the commands—

1. "In train, left, (or right,)"
2. "March."

At the second command, each detachment and wagon will be turned in the direction indicated and move forward in column without further command.

The train being in column, in order to change the march directly to the rear, the command will be given—

1. "Countermarch right, (or left,)"
2. "March."

At the second command, the detachments and wagons halt, with the exception of the director and markers, who wheel about to the right (or left) and move toward the rear of the train, followed in succession by the detachments and wagons which wheel about in turn into their places in the moving column.

When the train is in line or in column, and it is desired to gain distance to the rear without preserving the prescribed formation, the command will be—

1. "Train right (or left) about,"
2. "March."

At the second command, each detachment will wheel about to the right, (or left;) the wagons at a trot will move to the left (or right) and then wheel to the right (or left) about and take walk when they have their proper distance. If this command be given when the train is in line, the guide will be changed when the new direction is taken.

The train being in march, and it is desired to park it in the line of direction of march, the chief of train will command—

1. "Forward into park,"
2. "March."

At the first command, the chief of section will command "right oblique."

At the second command, repeated by the chief of section, the director and markers and the detachments oblique ten paces to the right, when he will command—

1. "Left front into line,"
2. "March."

At the second command, the director and markers halt and the detachments execute the prescribed movement; the battery-wagon obliques to the right and moves at the command "march" to take the post ten (10) paces in rear of the right of the detachment of bar-men; the wire-wagon moves to take post on line with and ten (10) paces to the left of the battery-wagon; the lance-truck moves into position ten (10) paces to the rear and in center of the two wagons and halts.

To go into park on the left of the line of march, the command will be given—

1. "Left into park,"
2. "March."

At the second command, the director and markers and the detachments wheel to the left and, dressing to the right, march thirty(30) paces to the front, when they will be halted by the chief of section and aligned on the director; the wagons continue the march until the battery-wagon is opposite the detachment of bar-men, when it wheels to the left and takes post ten (10) paces in rear of the right of that detachment. The wire-wagon and lance-

truck follow, and take their prescribed posts, as in the usual formation. (Fig. 36.)

To go into park on the right of the line of march, the commands are—

1. "Right into park,"
2. "March,"

and they are executed by reverse movements to those prescribed for "left into park;" but in this case the wire-wagon will pass the battery-wagon before turning to the right.

The drill being dismissed, the detachments will be marched by their respective chiefs to the parade, where they will be dismissed.

Fig. 37 shows the position of a full train in park.

#### GENERAL DIRECTIONS FOR RUNNING AND ERECTION OF FIELD-TELEGRAPH LINES.

They should be as nearly straight as the circumstances will allow. When it is impracticable for any reason to follow a straight line, the divergence should be made with a tree, house, or other firm support at the angle, and this especially if the divergence is large, approaching a right angle. Should such support be unavailable, two or three lances should be set close together to divide the strain.

When following a road or highway, the line should be placed beyond the ditch, so as to be entirely out of the way of trains. When crossing country, the same object should be kept in view, and the line run along the edge of timber, or the brink of ravines, avoiding ground likely to be selected for the parking of trains, or upon or across which artillery is likely to be moved.

In crossing broken country, the surveyor should be

PLATE XLI.

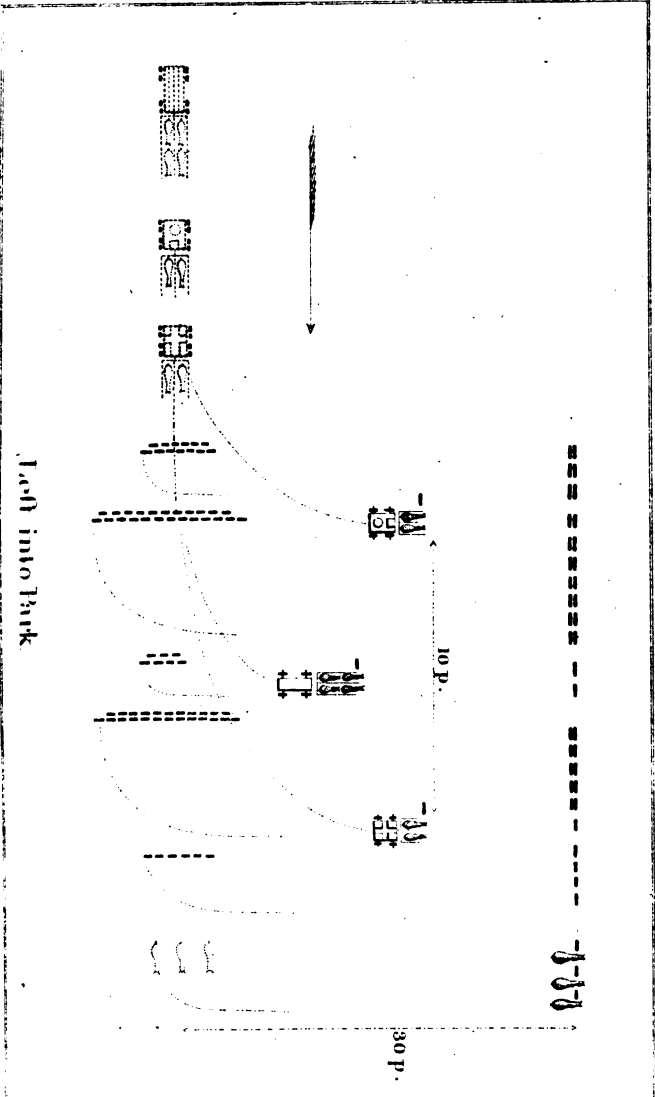
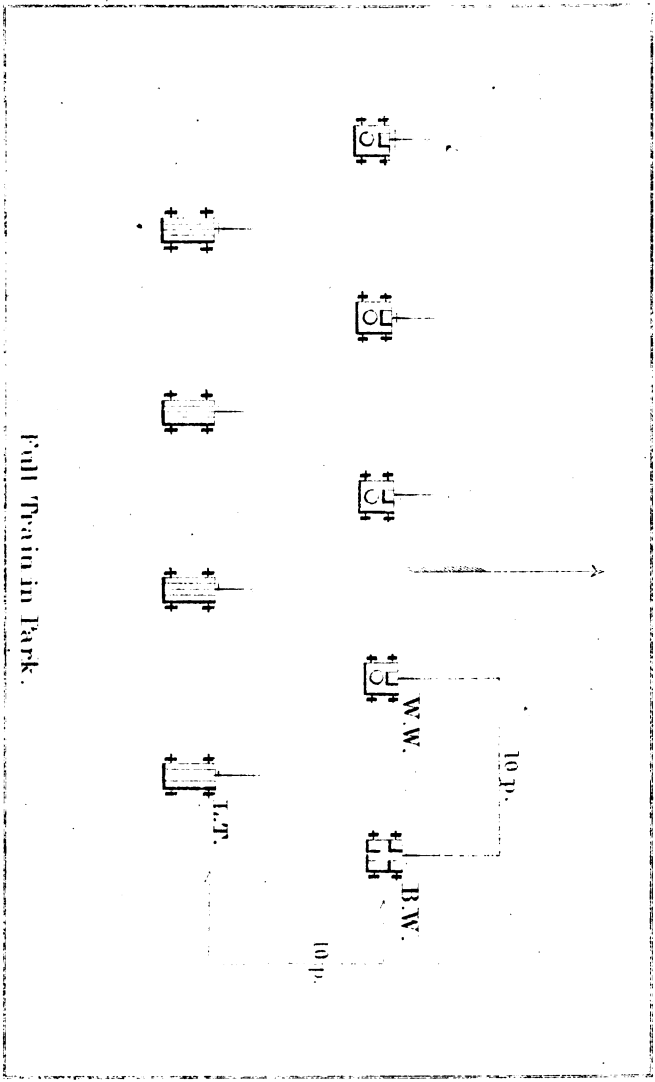



PLATE XXI.



Full Train in Tank.



careful to place lances upon the brink of declivities and on the top of knolls, in order that no ground between lances shall be high enough to endanger the line, should troops or trains pass under it.

Cross roads as seldom as possible, and, when necessary to do so, select, if possible, a point where the road is lower than the banks on either side.

Select ground in which the lance-holes can be easily and quickly made, but avoid sand. Lances should be fifty-three (53) steps apart, but this distance may be varied five (5) to ten (10) steps, to avoid bad ground, hard clay, rock, or dry sand.

The sergeant in charge must see that the lance-holes are made of proper depth and large enough to admit the foot of the lance easily.

The lance-men must force the lances down to the bottom of the hole, and stamp the earth about the lance to make it stand firmly; the insulator-spike must stand at right angles with the course of the line and the insulators be all on one side of the line of poles.

The wire-men will deliver the wire from the reel only as fast as the wagon moves, allowing no slack, in order that, when lifted on the lances, it shall be tight, and not hang in loose curves.

Clamp-hook insulators should be put on every fourth pole and on the poles next to a telegraphic instrument.

FORM FOR INSPECTION AND REVIEW FOR SECTION-  
TRAIN.

FORM FOR REVIEW.

The train will be conducted to the ground appointed for the review by the chief of train, and formed "in line



right, (or left,)" facing the stand of the reviewing officer, with the director and markers on the right.

The chief of train takes his place twenty (20) paces to the front and center of the train, facing from it; the chief of section six (6) paces to the front and center of the line of detachments. (Fig. 38.)

At the approach of the reviewing officer, he is received by the chief of train by an individual salute, and the latter advances, faces the train, and commands—

1. "Prepare for review."
2. "Detachments to the rear, open order,"
3. "March."

At the command "march," the director and markers and drivers dismount and stand at the heads of their horses. The chief of train and chief of section will remain mounted if the inspector is mounted.

The chief of section, after dressing the front and rear ranks of the detachments, returns to his place in line, when the chief of train commands—

"Front."

He will then accompany the reviewing officer along the front of the train from right to left, along the rear back again to the right and front, and take his post.

As soon as the reviewing officer takes his stand, the chief of train faces about and commands—

1. "Close order,"
2. "March."

At the second command, the ranks are closed and the director and markers mount. The commands will then be given—

1. "Pass in review."
2. "In train, right,"
3. "March."

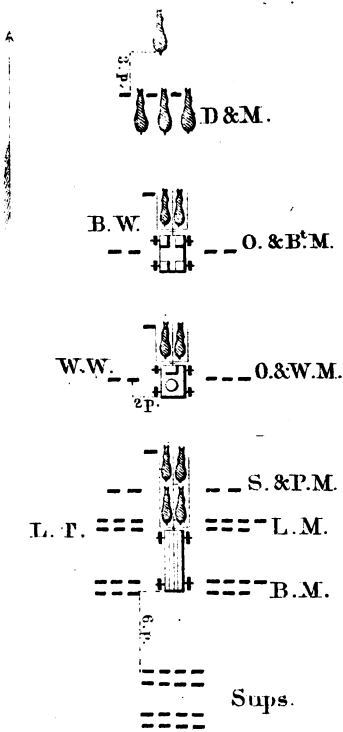



The chief of train then takes his place three (3) paces in front of the director and markers, and conducts the column in review past the reviewing officer, the right guides or chiefs of detachments passing within six (6) paces of the latter. The chief of train leaves the head of column after saluting the reviewing officer and remains at his side until the train passes, when he will again take charge, and, if required, pass the train again in double time. When the train passes in double time, no salutes will be given.

Having finally arrived upon the ground where the line was first established, it will again form by the command—

1. "In line, left,"
2. "March."
3. "Halt."
4. "Right dress."
5. "Front."

The chief of train then takes his post and reports, saluting as before.

The change of direction in passing in review will be indicated by fixed guidons or use of the mounted markers

If the ceremony terminates with a review, the train is at once parked and dismissed.

#### FORM FOR INSPECTION.

If an inspection is to follow the review, the chief of train will command—

1. "Prepare for inspection."
2. "In train, right,"
3. "March."
4. "Halt."

5. "Detachments, rear, open order,"
6. "March."
7. "Front."

At the third command, the detachments and wagons will be wheeled to the right and move forward in column.

The fourth command will be given as soon as the wagons gain their places in column, covering as little ground as possible, when the lieutenant will take post three (3) paces in front of his section.

The chief of section takes his place six (6) paces from the head of the column. The director and markers and drivers dismount. At the sixth command, when the detachments are brought to "rear, open order," the chiefs of detachments remain at the right of the front rank of their detachments.

The inspector, commencing at the head of column, regularly inspects the detachments and wagons in succession, and as soon as he has finished the ranks will be closed by the chief of train, and, unless a drill is ordered, the train will be at once dismissed.

## CHAPTER X.

The lines being erected, the offices must be arranged for the transaction of business; and, in case of field or flying telegraphs, this is a plain matter, the description of the wagons of the train and directions for use already given having covered the ground. At the central station or battery-wagon, the ground-bar is connected to the zinc or negative pole of the battery, the copper or positive pole is connected to one of the screw-posts of the instrument and the line-wire to the opposite screw-post. At the outer station, the connections are the same, except that the zinc pole of the battery is connected to line-wire (through the instrument) and the copper pole to the ground. At an intermediate station, if any exists, there is no ground-connection, the line-wire being cut and the instrument inserted so that it forms part of the circuit.

Upon permanent lines, where the ordinary Morse instruments are used, the combination of the main and local circuits makes the arrangement of the offices somewhat more difficult, and a few plain directions may be needed. In a terminal office, the battery having been placed in position and the ground-connection made, a wire, equal in conducting capacity to the ground-wire, runs to the switch-board in the instrument or operating-room. From the switch-board, as many wires as there may be lines to be worked run to the several instrument-tables connecting through the relay and key of each and return through the switch-board to the line-

wires. Under each table, or in some convenient place, is erected a local battery, the wires from which connect through the magnets of the sounder and the "points" of the relay. At intermediate offices, the battery and ground-connection are left out, the line-wires connect through relay and key, and the local wires are run as in the terminal offices. At intermediate offices, on both field and permanent lines, ground-connections should be prepared and in readiness for use in testing the lines or to enable the office to work to or with that terminal office to which the connection by line-wire is perfect in case of a break in the line. This will be shown in the directions for testing. Ordinarily, on military lines, the switch-boards will be unused, the line-wire run directly to the instrument on one side and the wire from the battery to the opposite, the switch-board being a convenience merely, and not a necessity. The fundamental conditions are that the line-wires be so connected as that the current generated by the main battery, and flowing through them, shall pass through the magnet of the relay and the insulated post and circuit-closer of the key, and that the local wires be so connected that the current of the local battery must pass through the magnet of the sounder and the "points" of the relay. If these are fulfilled the office is ready for business.

The alphabet used is the "General Service Code" of the Army and Navy, and the signal-numerals thereof are transmitted by blows of the key, like the dots of the Morse alphabet, one blow indicating the numeral 1 and a double blow (two blows made without interval) the numeral 2. It is received by sound, the stroke of the armature of the magnet making the sound.

Written with pen or pencil, the code is this:

Alphabet.	Flag-code.	Telegraph.
A	22	.. ..
B	2112	.. . . .
C	121	. .. .
D	222	.. .. .
E	12	. . . .
F	2221	.. .. .
G	2211	.. .. .
H	122	. . . .
I	1	. . . .
J	1122	. . . . .
K	2121	.. .. .
L	221	. . . . .
M	1221	. . . . .
N	11	. . . . .
O	21	. . . . .
P	1212	. . . . .
Q	1211	. . . . .
R	211	. . . . .
S	212	.. .. .
T	2	. . . . .
U	112	. . . . .
V	1222	. . . . .
W	1121	. . . . .
X	2122	.. .. .
Y	111	. . . . .
Z	2222	.. .. .
ing	2212	.. .. .
tion	1112	. . . . .
&	1111	. . . . .
1	21112	.. . . . .
2	12221	. . . . .
3	22122	.. .. .
4	22212	.. .. .
5	22221	.. .. .
6	12225	. . . . .
7	11222	. . . . .
8	11112	. . . . .
9	11211	. . . . .
0	22222	.. .. .

Three blows or strokes, without interval, is full stop, and is the only punctuation-mark used.



The points or dots in the above code represent, as has been said, sounds, the single dots single blows of the key in sending, or of the armature in receiving, signals, and the double ones double blows. It must be borne in mind that the instrument makes two sounds for each stroke of the key, one by the forward motion of the armature, corresponding to the stroke of the key, and a second by the backward motion of the armature, which occurs when the key is raised or opened. Thus the signal-numeral 1, which is represented in the printed code by one dot, is heard by the operator as the sound of two blows, (differing in tone,) the numeral 2 by four such sounds, (two of each tone,) and the 3 by six. It will be seen that the blows of the forward motion only are significant, those of the backward motion being the result of a "return to position" by the armature. The spaces between them represent intervals of time equal to those occupied in giving the blows. In combining the alphabetic signals to form words, this interval must be increased. The rule of practice is this: Whatever the rate of signaling, the time occupied in giving the stroke is the unit of time. Between the signal numerals of any combination allow one unit of time to intervene. Between letter-combinations (including, of course, abbreviations and numerals) allow two units; between words, four units.

Messages can be sent in this code at from fifteen to eighteen words per minute, but ten words per minute is a good rate of speed, and as much as is safe, if the message is enciphered.

The blows of the key must be firmly and evenly made, especial care being taken to avoid nervousness and haste, which produce uncertain sounds and confuse the receiver.

Five words per minute, which the receiver can read without "breaking" or calling for repetitions, is a better rate and will accomplish more in an hour than double or treble that rate interrupted by breaks and frequent repetitions, not to mention the liability to error, which increases rapidly as the rate of transmission is accelerated.

Each office or station will be known by a signal peculiar to itself, which is its "call," and each operator by a personal signal, (usually the initial of the name of the person.)

When a message is received at one station for transmission to another, the operator on duty will "call" the station wanted, by repeating its signal four times, and then that of his own station, and continuing until the signal is perceived and answered. The answer is given by the operator on duty at the called station, by opening the circuit, upon which the caller closes, and the called station signals G. A. and the signal of the station. The operator who called, then forwards the message, and concludes by sending his own personal signal. The operator receiving the message acknowledges the receipt thereof by signaling O. K. and his personal signal.

When not in use—that is, when no one is signaling—all the circuit-closers are closed—placed in contact—so that the battery-current finds an uninterrupted path, and flows constantly, keeping all the magnets active. This is necessary in order that the line may be ready for use by any station, whether terminal or intermediate, upon it; and, to understand how this necessity arises, it is necessary to comprehend the relation of the parts of the line to each other and the manner in which the sounds are produced.

The batteries furnish the current, which is the power

by which the signals are made, the conducting-wires carry this current to the points which it is desired to connect, and the instruments are the devices by which the current is manipulated so as to form signals, and by which these signals are made intelligible to the eye or ear of the receiver.

The key has already been described and its offices indicated, as also the receiving-instrument; but the essential portion of any such instrument, relay, sounder, or field-instrument—the electro-magnet—must be thoroughly understood by the student.

An electro-magnet is composed of a soft-iron core, usually, though not necessarily, approaching a horseshoe form, around which is coiled an insulated conductor. When an electric current is transmitted through the conductor, the iron core becomes magnetic, and continues magnetic as long as the current continues to flow, losing that property again, quickly, upon the cessation of the current.

The batteries and ground-connections being at either end of the line, all the instruments intervening, it will be seen that when all keys are closed (*i. e.*, circuit-closers in contact) the current is constantly flowing, and the iron cores of all the instruments in circuit magnetized. It follows that by the opening of any one key (circuit-closer not in contact) the circuit or path of the current is interrupted or broken, the current ceases to flow, and the cores are demagnetized. As it is by the alternate magnetization and demagnetization of these cores, made recognizable by the motion of the armatures, that signals are transmitted, the necessity for placing the circuit-closers in contact (in telegraphic phrase, “closing the key”) becomes apparent. It may be further seen that, while all the offices on any

line may receive at the same time what any one may be transmitting, only one operator can be transmitting, and, therefore, the necessity for a careful adjustment of the instrument by the operator, constant attention thereto at all times, and especially before attempting to transmit signals.

By "adjustment" is meant such a regulation of the distance between the poles of the electro-magnet (*i. e.*, the ends of the iron core) and its armature, and of the tension of the armature-spring, as that the armature shall obey the attraction of the magnet when that force is excited by the flow of the current, and move to the front contact promptly, while the tension of the spring shall be sufficient to overcome the residual magnetism of the iron and any attraction which may result from the flow of current consequent on defective insulation, and withdraw the armature to the back contact upon the opening of any key.

By the phrase "residual magnetism" allusion is made to the fact that the attractive power of the iron is developed gradually and gradually lost, so that in ordinary signaling the force of attraction generated by one signal-impulse is not entirely discharged or dissipated before the succeeding impulse is commenced, the result being that the iron is at all times magnetic; strongly so when the current is flowing and weakly in the intervals. This weak attraction is called "residual magnetism," and must be counterbalanced by the elasticity of the spring. In addition to the residual magnetism, the spring must overcome any attraction of the magnet resulting from escape. On all lines of any considerable length, a portion of the current passes to the earth through or over the supports, or at points of accidental contact with trees.

buildings, &c. This flow develops the magnetism of the iron in proportion to its amount; and this attraction must also (as has been said) be balanced by the tension of the spring.

As these forces are both variable, the closest attention is required, and frequent tests must be made by the operator to be certain that the instrument is properly adjusted. On a line which is well insulated, having little loss by escape, the adjustment will be comparatively easy, the difference to be guarded against being that in the rate of speed by different signalists. If a large interval is allowed between the signals, giving time for the discharge of the magnetism of the cores, the signals will be clear with a low tension of the spring; if, on the contrary, the signals follow each other rapidly, a higher tension will be necessary to overcome the residual magnetism. A safe rule is to adjust high enough to get the quickest signals distinctly. Upon a badly insulated line, the matter is more difficult. In this case, the adjustment necessary to get the signals from the distant station may be so high as to prevent, or render difficult, the reception of the signals made by a nearer station. Suppose a line with two terminal and three intermediate stations, equidistant, which loses by defective insulation three-fourths of the current generated by its batteries, the loss being distributed equally over its whole length. The opening of the key at one terminal leaves the instrument at the other still acted upon by three-fourths of its battery-current, which flows out at the points of escape, and to recognize the signals the adjustment must be high enough to balance three-fourths of the power of the magnet as excited by the battery-current. At the station next nearer, the opening of the key would cut off the one-

fourth of the current which goes to ground at the terminus, and in addition thereto one-fourth of the escape, as one-fourth of the line lies beyond it. At the middle station the open key would cut off one-half the escape, and at the third, or nearest intermediate, station, three-fourths of the escape, in addition to the one-fourth that would go through; and thus is rendered necessary a different adjustment to enable the operator at the one terminal to work with the other and with each of the intermediate stations. Practice only can give the operator skill in this respect, and too much attention can scarcely be given it, as from want of skill in adjusting arises much of the delay in transmission of messages, interference with each other by operators, misunderstanding of signals, &c.

## CHAPTER XI.

Telegraph-lines are subject to three contingencies which may impede or prevent the transmission of signals. These are the breaking of the conductor, by which the transmission of the signals will be prevented; the loss of current by contact with the ground, (or with other conducting bodies which connect with the ground,) which will render the transmission of signals difficult in proportion as the loss of current is greater or less; and contact between two wires, by which the signals passing upon either may interfere with and confuse those of the other. The first are known as breaks, the second as grounds, (total or partial,) and the third as crosses.

The operation necessary to determine what the fault is, when one is found to exist, and where it is, in order to direct concerning its removal, or to devise means of avoiding or overcoming the difficulty in signaling, is called testing.

This may be, and on long lines without intermediate stations, whether aerial, subterranean, or submarine, necessarily is, performed by the aid of a galvanometer and artificial resistance. These methods are many, and are capable of locating and defining a fault with great certainty and exactness, by comparing the known resistances with the unknown; but, as the delicate instruments and apparatus are unfit for military service, and the conditions precedent necessary to testing in this manner generally wanting on military lines, the student is referred to more elaborate works for a knowledge thereof,

and the common methods of testing with the ordinary instruments only will be considered. If a line be broken, and the broken ends of the wire prevented from falling to the ground, or having fallen rest on dry earth or sand, the apparent result will be a stoppage of the battery-current, made appreciable by the non-action of the magnets at the adjustment in use previous to the breaking of the wire. Attempts to adjust the magnets to the new condition will show no current if the accidental connection to earth be very slight, and in any case only such as is due to escape, over-defective insulation, and the imperfect contact at the break. The work of locating such faults lies with the intermediate offices. When the power of the magnet is much reduced or lost at any station intermediate between the termini of a line, the operator should, by placing his ground-wire in connection with the line on one side or the other of his instrument, ascertain in which direction the fault lies. If with the ground-wire on one side he finds the power of the magnet restored, the fault is beyond the ground-wire. If with the ground-wire on the opposite side he receives a feeble current, indicated by a weak action of the magnet, the line is on the earth, but not broken. If no current is received, the line-wire is broken. If, after testing on each side, no effect is found, (the magnet remaining inactive,) the probability is that the fault is in the testing-office, and it should be at once cut out and carefully inspected and tested. Fig. 39 is a diagram of a line with four stations, broken between the intermediate or "way" stations. It will be seen that there are formed by the use of the ground-wires at the way stations two separate circuits, one from A to B, the power furnished by the

7 M T



battery at A, and one from C to D, the battery at D furnishing the power.

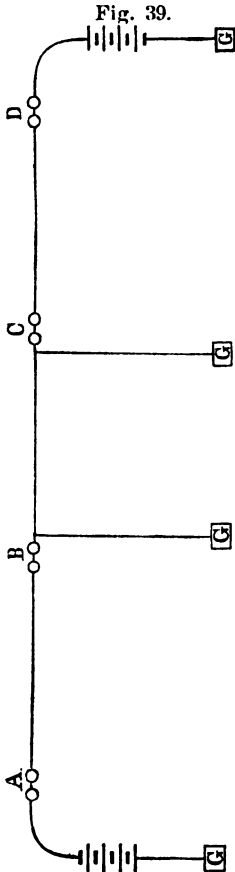

Were the line not broken, but merely thrown upon moist earth at the same point, the result would be the same, practically, without the use of the ground-wires, the earth-contact acting as ground.

Breaks are usually the result of violence to the line-wire, but occur not infrequently in offices by the carelessness of an operator in not closing his circuit after working, or by the loosening of a binding-screw about the instrument or switch. The fine wire of which the coils of the magnets are made is sometimes burned off by atmospheric electricity, with the same result.

When a break has been improperly repaired, as by making a "hook-joint," (so called,) by which the conducting capacity of the line is but partially restored, the result is the same as though additional wire had been attached; the battery-current, encountering more resistance, excites the magnet less powerfully, and the transmission of signals is less prompt and certain. This fault may be found in the same manner, or if there be more than one wire the device of cross-connecting them may be made use of.

Fig. 40 represents a line having two conductors and intermediate stations. A partial disconnection exists at F in No. 2 wire, which, by cross-connecting at A and B, is shifted into No. 1 wire at the terminals, showing that it is between the cross-connections. It will be seen that any fault, except a cross, (which affects both wires alike,) can be tested for in the same manner.

Grounds are tested for by a terminal station by calling the most distant station and noting the strength of the current, (by its effect on the magnet,) when the circuit is left open, and the tension of adjustment-spring necessary to get signals clearly from the distant office, and by comparison with the results of the same experiments with the other stations in succession. When the open key shows only the ordinary amount of escape, and the signals come clearly at the ordinary adjustment, the fault is passed. If the change is sudden, the current is escaping principally at one point between the last station, which required a "high" adjustment, and the first, which worked on a lower. If the change is gradual, as station after station is tested with, the fault is a general defect in insulation, broken or faulty insulators, or contact with trees, shrubs, &c.

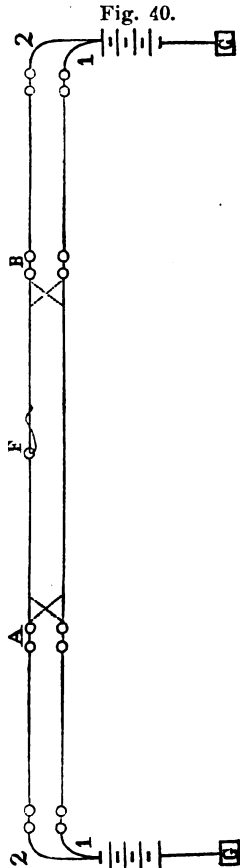

Crosses may occur between the wires of an intersecting line, in which case they can be tested for by the same methods as those employed to locate grounds, or between parallel wires of the same line. When the latter is the case the terminal station conducting the test should direct the other terminal station to open circuit on one of the wires, and each of the intermediate stations, one after the other, commencing with the most distant, to make signals is on the wire which remains closed. As long as the cross between the operator making the signals and the testing-terminus, the signals will come on both wires, but as soon as the cross is more distant than the signaling operator, they will come on the one in which they are made only, the other remaining closed.

If one of the wires only is in the way stations, the testing terminals can make a loop-test by directing the other terminus to open circuit on both wires, and connecting one of them to earth outside the battery. Signals made at the testing-station will then go out on one wire to the cross and back on the other to earth, and the cross will be found beyond the farthest station that hears the signals. All stations beyond the cross will have open circuit or no current.

While a cross exists one wire should be kept open in order that the other may work uninterruptedly; or, having located it, let the stations on either side disconnect the line-wire from their instruments on the side next the "cross," and substitute a ground-wire. The terminus can then use one wire "through," and each can reach the way-stations between itself and the fault by the ends of the bisected wire.





William A. Richardson.

*Assistant Secretary of the Treasury.*

137 East Capitol Street.

Eng 4348.72.2  
A Manual of military telegraphy for  
Cabot Science 006834478



3 2044 092 013 820