

Memory is arranged in your computer as follows:

Base RAM (Conventional Memory)--Memory below 640KB, which can be used by MS-DOS and all MS-DOS applications without requiring drivers.

Shadow RAM--Memory from 640KB to 1024KB (1MB), which is used by the system BIOS, video BIOS, and other BIOS extensions.

Extended Memory--Continuous memory above 1MB, which can be addressed directly by 80286, 386SX, 386DX, i486, i486 DX, and i486 DX2 microprocessors. Extended memory is often used for software disk caches, RAM disks, and software print spoolers. Extended memory can also be directly used by software like Microsoft Windows or MS-DOS through the use of a DOS extender. Other operating systems such as OS/2 or UNIX can also use extended memory. MS-DOS 5.0 includes an extended memory manager called HIMEM.SYS. Refer to the MS-DOS 5.0 documentation for information about HIMEM.SYS.

The following diagram illustrates the arrangement of memory in your computer. The diagram also shows cacheable and non-cacheable areas.

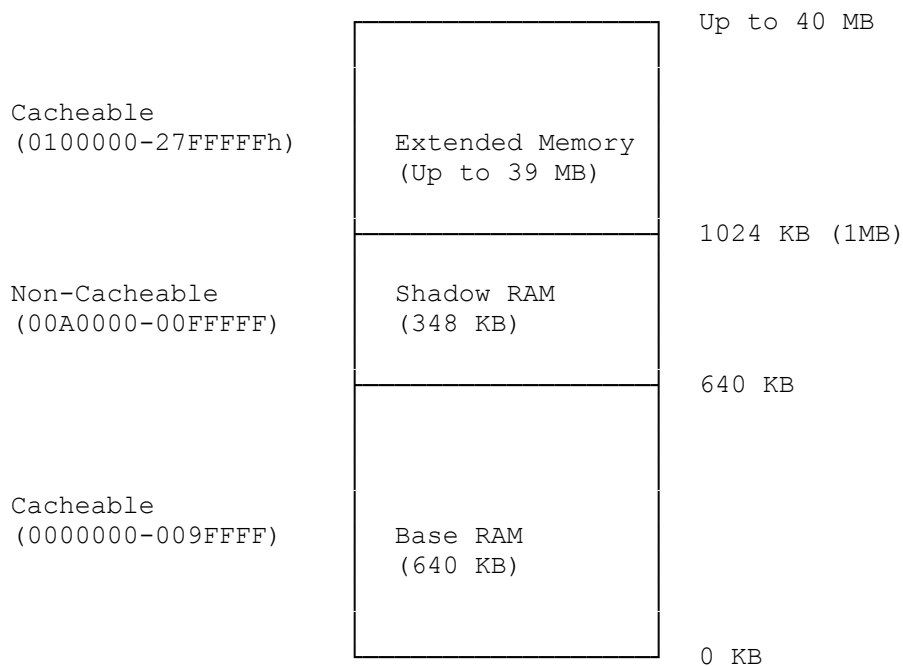

(smm 08/24/93)