

ZARM Drop Tower Bremen User Manual

Version: June 20, 2011

Balancing of the catapult capsule
specified on page 15

Drop Tower Operation and Service Company
ZARM FABmbH
Am Fallturm
D-28359 Bremen
Phone: +49-(0)421-218-4078
Fax: +49-(0)421-218-3889
e-mail: fab@zarm.uni-bremen.de

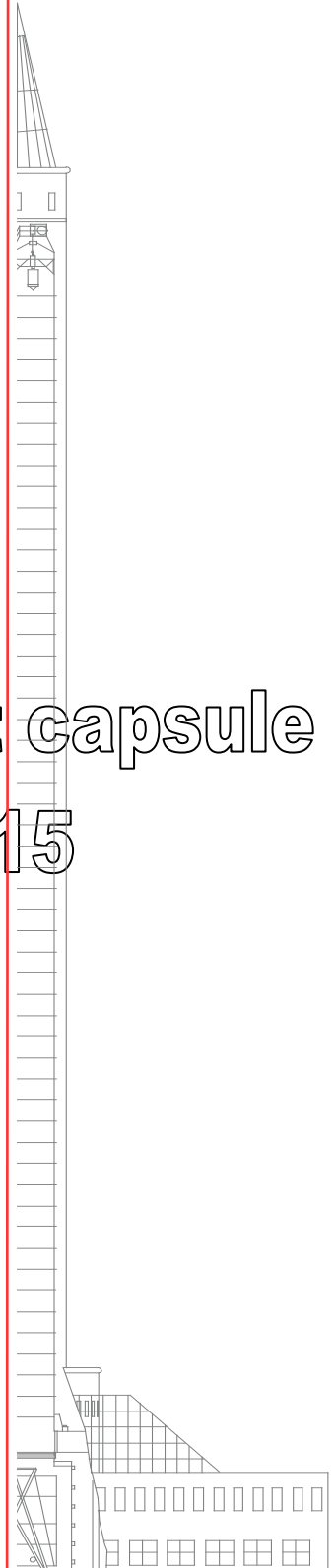

Version history:

<i>March 12, 2005</i>	Introduction of new Capsule Computer System, CCS, National Instruments™.
<i>April 15, 2005</i>	Introduction of new DVCAM™-System.
<i>Oct. 2, 2007</i>	Correction: table 3, page 19: NC, NO-pins exchanged. Catapult-System, figure 4, detailed microgravity environment information, figure counting
<i>Nov. 1, 2007</i>	Detailing of the Safety Requirements, page 28 Table 1, page 16, including catapult capsule masses and dimensions
<i>Dec. 17, 2008</i>	New High-Speed Imaging System, page 38
<i>Sept. 29, 2009</i>	Micro-g Centrifuge described in more detail, page 41. Former chapter 5.8 (Free Flyer) defunct.
<i>Oct. 9, 2009</i>	Misprint corrections
<i>August 20, 2010</i>	Chapter 2.4.1 Dimension of payload area altered. Chapter 2.4.2.1 Power distribution unit changed from 28 VDC to 24 VDC. Chapter 2.4.3.2 I/O Experiment interface description changed. Pressurized air reservoir stringer defunct. Combustion laser diagnostics defunct.
<i>January 24, 2011</i>	Download-link altered. Phone number. Dr. Thorben Könemann altered.
<i>June 20, 2011</i>	Balancing of a Catapult Capsule specified on page 15

How to read this Manual

This manual shall serve for both, as a general introduction into microgravity research as well as a detailed user's manual describing all mechanical, electrical and electronic interfaces and control software that you need to know before starting to design a drop tower experiment.

As your experiment can only be integrated if in accordance with the given boundary conditions, it is mandatory to refer to it. When reading this manual is your first approach to a drop tower experiment, it is recommended to read it carefully from the beginning. Later you may refer to the related chapters.

As our aim is to serve the scientists needs as best as possible, please contact us if you cannot find technical issues that are important for you. Keep in mind, that many items of the technical equipment have been implemented upon former users requests.

As the drop tower facility is a cutting edge facility for microgravity research, it is under constant development. Even though we try to be downward compatible with any new development, this can not be guaranteed in any case. Therefore, for most actual information please refer to our web-page:

<http://www.zarm.uni-bremen.de/drop-tower/downloads/>

or directly contact:

Drop Tower Operation and Service Company
ZARM FABmbH
Am Fallturm
D-28359 Bremen
Phone: +49-(0)421-218-4078
Fax: +49-(0)421-218-3889
e-mail: fab@zarm.uni-bremen.de

page intentionally left free

Content

0	Preface to the catapult operation	7
1	Time-line of a standard campaign.....	8
2	The Experimental Set-up	11
2.1	Important acronyms.....	11
2.2	Integration of an Experiment	11
2.3	The Workplace	11
2.4	The Drop Capsule, Mechanics and Interfaces	12
2.4.1	The Drop Capsule, mechanically	12
2.4.1.1	Experiment-Platforms.....	17
2.4.2	The Drop Capsule, electrically	18
2.4.2.1	Power Distribution Unit (PDU).....	18
2.4.2.2	Electromagnetic compatibility	19
2.4.3	The Drop Capsule, electronically	20
2.4.3.1	Experiment Control.....	20
2.4.3.2	The Capsule Control System (CCS).....	20
3	Safety requirements.....	28
4	Experiment Environment Conditions.....	30
4.1	Pressure Environment.....	30
4.2	Thermal Environment	30
4.3	Accelerations.....	31
5	Special Equipment	36
5.1	CCD-Cameras, VCR´s, Lenses.....	36
5.2	Digital High-Speed CMOS Imaging System	38
5.3	Heating and Cooling Devices	39
5.4	Non-Standard Voltage-/ Current-Supply.....	40
5.5	Vent-Line	40
5.6	Micro-g Centrifuge.....	41

page intentionally left free

0 Preface to the catapult operation

With the version Oct. 2, 2007 of this manual, the fully developed drop tower catapult is implemented into the scientific drop tower routine.

By means of the catapult operation mode, which is throwing the drop capsule from the bottom of the tower in a vertical parabola to the top and back to the deceleration chamber, the microgravity experiment time can be expanded from 4.74 seconds to 9.3 seconds at present.

Even though the quality of microgravity could be kept at very low levels below $10^{-5} g_0$, there is one important difference: the catapult experiment is induced via an acceleration of approx. 280 ms duration with a peak value of $30 g_0$ descending into $10^{-6} g_0$ (see Fig. 11) while the normal dropping procedure is induced via a transition from $1 g_0$ to $10^{-6} g_0$. Not any experiment might thus be able to take advantage of the catapult operation. This must be subjected to a detailed review of the particular case.

As the main guideline during the catapult design was to keep all interfaces identical to the normal dropping mode, to describe the catapult operation in an individual chapter is of no meaning. Therefore, those information which are important and describe differences to drop tower operation are worked into the manual and appear at the related position.

Please note, that the catapult is a sophisticated instrument that we need to become carefully acquainted with. At present, some instruments or operation modes available for dropping procedure are therefore not available for catapult operation. This is for the sake of a secure operation and might be subjected to changes by time.

1 Time-line of a standard campaign

Despite the fact, that the definition of a standard campaign is the statistical evaluation of some hundred campaigns up to now and might differ in specific cases, it might help you to imagine how the system is operated and how your experiment is implemented into the operation routine.

Described is only the technical pathway. Administrative and contractual issues are a parallel routine not described here.

1. First contact to ZARM-FABmbH giving a description (text, schemes, drawings) of what you intend to do.

Contact: Christian Eigenbrod
Scientific and Technical Director
Phone: +49-421-218-4078
Fax: +49-421-218-3889
e-mail: fab@zarm.uni-bremen.de

or

Thorben Koenemann
Deputy Scientific Director
Phone: +49-421-218-8247
Fax: +49-421-218-3889
e-mail: thorben.koenemann@zarm.uni-bremen.de

or

Ulrich Kaczmarczik
Deputy Technical Director
Phone: +49-421-218-4807
Fax: +49-421-219-3889
e-mail: ulrich.kaczmarczik@zarm.uni-bremen.de

2. Shipping of experiment platforms to your lab. Preassembly of the setup to the platforms.

For detailed technical discussion:

Contact: for mechanical questions
Manfred Behrens
Phone: +49-421-218-4114
Fax: +49-421-218-3889
e-mail: manfred.behrens@zarm.uni-bremen.de

Contact: for electronic interface- and software questions
Torsten Lutz
Phone: +49-421-218-4807
Fax: +49-421-218-3889
e-mail: torsten.lutz@zarm.uni-bremen.de

Contact: for scheduling of campaign
Torsten Lutz
Phone: +49-421-218-4807
Fax: +49-421-218-3889

e-mail: torsten.lutz@zarm.uni-bremen.de
Contact: for contractual and administrative affairs
Peter von Kampen
Phone: +49-421-218-4804
Fax: +49-421-218-3889
e-mail: peter.vonkampen@zarm.uni-bremen.de

3. After scheduling of your campaign you are expected at the drop tower  **min. 10 working days before the first drop.** This time is needed for integration and ground testing. As the drop tower is operated along a strict schedule (comparable to an airline) the time for integration and testing must be sufficient in order to prevent from losing experiment opportunities due to delays. For further campaigns this time might be reduced as appropriate.

4. The drop tower is operated with three drops per day (not necessarily with the same experiment). Each week has 4 operation days. The Monday is reserved for system maintenance. Each drop sequence, calculated from handover of the capsule to the operator until handover from operator back to you, lasts 4 hours including safety margins. The handover times are 8 a.m., 12 a.m., 4 p.m.. A delayed handover for more than 30 min. due to the experimenters responsibility will lead to cancellation of the drop from schedule. Nevertheless, the drop counts as performed. Therefore, you are encouraged to carefully monitor the preparation time you need, before scheduling a campaign. Even though we will try to handle this to your satisfaction, you are requested to keep this rules in mind as being mandatory.

5. After handover of the setup to the operator, the capsule will be closed, connected to the winding mechanism and lifted to the top of the tube / positioned on the catapult piston. During this process you have no remote access to the experiment for about 15 min.

6. After reaching the upper end of the tube / positioning on the catapult piston, the telemetry / telecommand line is checked and remote access is established. The experiment is now connected to all interfaces described in the manual.

7. About 2 hours after handover to the operator, the evacuation process is finished with achieving the final pressure of < 0.1 hPa (< 0.0015 psi) within the drop tube. Then the external supply units (DC power, battery charge and fluid supply) are disconnected. In the dropping case the experimenter now takes over operation and can drop the assembly whenever ready. Experimenter and operator are working at the same desk and can easily agree on the procedure.

In case of catapult flight approx. 10 minutes before launch the catapult system is going to be armed. The external supply units (DC power, battery charge and fluid supply) are disconnected. The catapult piston with the capsule is moved down to the launch position. After enabling by the operator the launch sequence can be started by the experimenter within the next 5 minutes time window. The time delay after launch initiation till launch execution is about 4 seconds.



Important note: The exceeding of this time window leads to the catapult experiment abort due to technical reasons.

8. After experiment deceleration, all data are stored onboard or downloaded for evaluation via the telemetry line. In parallel, the tube is re-flooded with air.

9. About 45 min later, the capsule has been retrieved, opened and handed back to the experimenter. The drop tower team will then perform a final check of the hardware.

10. A single campaign usually counts 8 to 24 drops (1 to 3 weeks, two drops a day). This might differ from experiment to experiment. It is meaningful, when firstly performing a campaign with a new experiment, to review the experiment after a shorter campaign before doing a longer campaign. This enables the experimenter to optimize the hardware and thus the scientific output. By the end of a campaign, the setup will be disintegrated with the experimenter. All specific parts fabricated at ZARM will be stored for a possible successive campaign.

2 The Experimental Set-up

2.1 Important acronyms

CCS:	<i>Capsule Control System</i> The electronic interface between experiment and experimenter. It is a computer system available in the drop capsule and at any EGSE
CC:	<i>Catapult Capsule</i>
EGSE:	<i>Electronic Ground Support Equipment</i> The interfaces at the working place in the integration hall. The EGSE delivers the identical mechanical-, electrical-, electronic- and software interfaces as in the drop tower. The only difference is g_0 . The computers are in a network, so that any change made at the EGSE will be automatically available in the drop tower routine too.
PDU:	<i>Power Distribution Unit</i> The connection box inside the capsule for electrical connection of the experiment
COG:	<i>Center of Gravity</i>
vgCCcl:	<i>vertical geometrical Catapult Capsule center line</i>
VI:	<i>Virtual Instrument</i>

2.2 Integration of an Experiment

During a drop tower campaign (incl. the initial consulting phase), each experiment is supported by two engineers. The one is mechanical engineer, the other electronic engineer. In case of special problems the team will be supported by other specialists. One of this crew always functions as crew-leader. For consultancy and integration works, the crew is always at hand. This team will also be your partner during the dropping procedure. During further campaigns of the same experiment, ZARM-FABmbH tries to regroup the same team composition with at least one identical person. Dependent on the complexity and the state of pre-integration at the scientists premise, integration lasts one to two weeks including ground testing. As the drop tower operation schedule must be strictly kept, the duration of the integration period will be defined in advance of a campaign. So both sides can rely on the time table.

2.3 The Workplace

Any drop tower user will get an integration place with workbenches, tools and an Electronic Ground Support Equipment EGSE within the hall surrounding the tower. The EGSE allows for performing ground experiments following the identical procedure as in the tower and under identical conditions (except from g -conditions of course) as often he wants and needs.



Fig. 1 Integration workplace with workbenches and experiment network connectors

2.4 The Drop Capsule, Mechanics and Interfaces

2.4.1 The Drop Capsule, mechanically

Experiments are accommodated inside a specially designed drop bus. The bus is pressurized to atmospheric pressure as well as shockproof in order to withstand the acceleration / deceleration forces. The main components are:

- Base structure
- Four stringer rack for experiment accommodation
- Pressurizable hull
- Lid plate with interfaces and release bolt

The base structure consists of the Capsule Control System CCS, the switchable power supply PDU and the radio telemetry / telecommand system with a W-LAN Unit on top of the capsule.

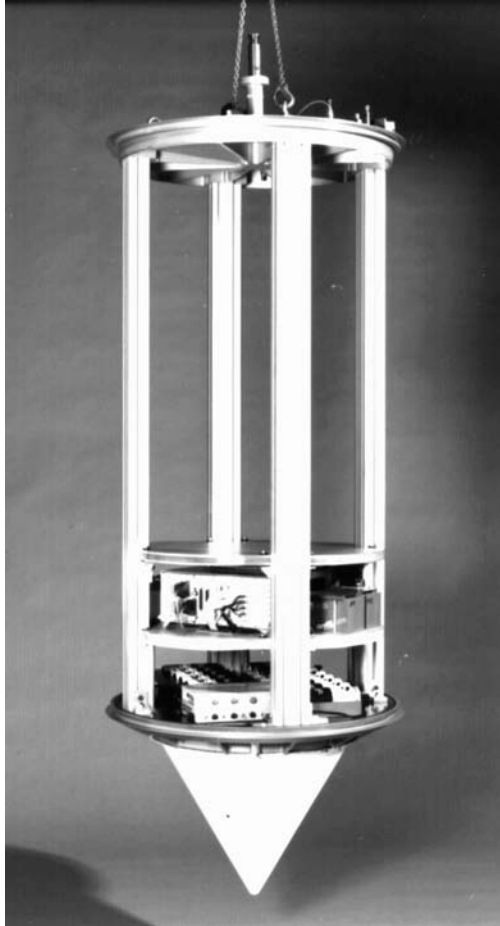

Fig. 2 Standard drop capsule (pressurizable cover is removed), short version

The different parts of an experiment are assembled on platforms (available via ZARM-FABmbH) and connected to the four stringers of the rig in variable height. Finally the stringer rig is set on the base structure and fixed.

When an experiment is foreseen for a drop tower campaign, the required number of platforms is shipped to the experimenter to enable him to preassemble the experiment if wanted. Dependent on the agencies contracts, a different number of platforms is included in the campaign contract free of charge. On request, a complete stringer rig including platforms and platform holders mounted in a rigid flight-case is available at ZARM-FABmbH for a reasonable price. This allows for safe transportation of widely preassembled rigs and ensures functioning even at the experimenters premise. As it can reduce accommodation costs due to shorter integration time the price comparison gets soon reasonable.

After arriving at the drop tower, the platforms are mounted into the rig and the rig is mounted to the base structure. After that, all electrical and electronic connections are lined between the platforms and the base structure along the stringers.

The time being, three different versions of drop rigs of different height of the payload area are available.

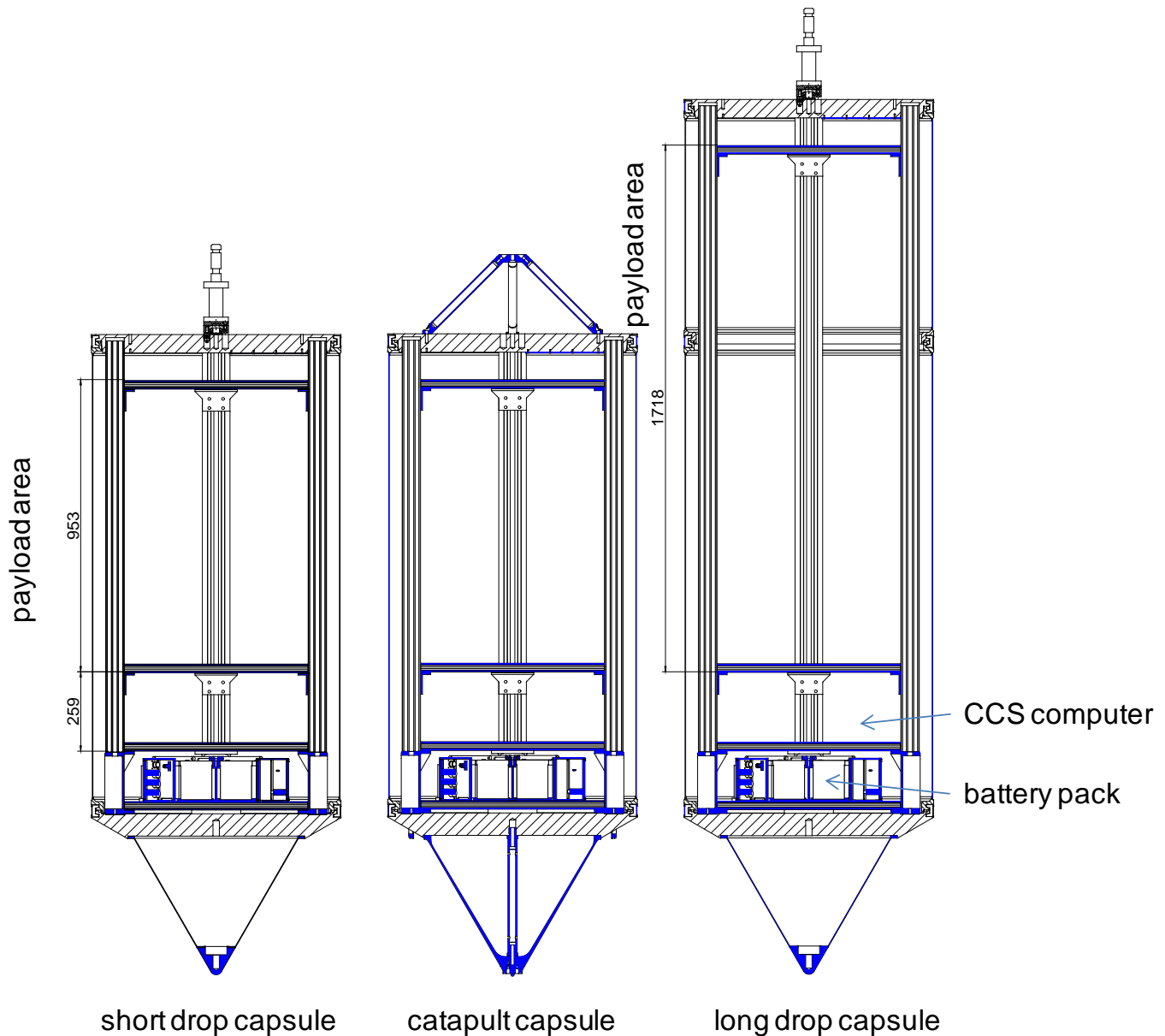

Fig. 3 The three versions of the drop tower capsule

The capsule should not be larger than necessary. At present, for catapult experiments only the short capsule version is available. Whenever the evolution of an experiment during the campaigns requests for more space, a transformation of a short into a long drop bus is possible – usually within one day.

When you start to mechanically design a drop tower experiment, the following technical data and limitations have to be strictly kept.

- The overall weight of a platform (including the platform itself) may not exceed 100 kg
- Point load of a platform (to the center) may not exceed 50 kg
- The distribution of mass should be evenly. The mass eccentricity should be as low as possible. If mass eccentricity is too high, additional counterbalance masses (accumulated to the payload) will be mounted to the rig at ZARM

Due to safety requirements it is mandatory to balance the **Catapult Capsule (CC)**. The procedure of balancing will take about 4 hours and will be performed on site by ZARM engineers after the setup has passed the test readiness review.

The COG has to be within a circle of 1 mm in diameter around the vertical geometrical Catapult Capsule center line (vgCCcl). Therefore all disassembling and reassembling of equipment inside the Catapult Capsule during a campaign must be done without shifting the COG outside this tolerance circle. If the technical setup does not fulfill the requirements above, a rebalancing will be necessary before the next catapult shot.

The maximum offset load can be calculated using the following simple equation:

$$\text{max. offset load [kg]} \times \text{dist. from vgCCcl [mm]} = \text{total mass of CC [kg]} \times 0.5 \text{ mm}$$

Example:

total mass of Catapult Capsule	= 400 kg
offset load with a distance to center line (vgCCcl)	= 300 mm

$$\text{max.offset load} = (400 \text{ kg} \times 0.5\text{mm}) / (300 \text{ mm}) = 0.667 \text{ kg}$$

 **With regard to the tight schedule of a drop tower campaign the experimenter shall assure that the experimental construction is made in a way that no part may shift its position during the experiment and the subsequent deceleration (e.g. a cable harness). Otherwise a re-balancing would become necessary before any drop.**

The actual Catapult Capsule “flight” weight limit of 400 kg includes the counter balance weights.

As soon as the capsule is balanced by the Drop Tower Crew any mechanical changes must be declared.

- When you mount a complete rig at your premise, the distance between the lower end of the stringers and the bottom side of the lowest experiment platform may not be less than 259 mm. This is the lower limit of the payload area.
- When you mount a complete rig at your premise, assure that all platform holders of one platform are exactly on the same level
- The overall height of the experiment may not exceed 953 mm (short capsule) or 1718 mm (long capsule) including the lower platform.
- The maximum overall mass of the drop capsule is 500 kg (400 kg catapult mode). Calculating the data from the table given below, this results in a maximum payload mass of 264.4 kg (short capsule) or 221.2 kg (long capsule) or 161.5 kg (short capsule, catapult mode).

 **Important note: All limitations are hard limits. It is strongly recommended to keep a safety distance from these limitations when firstly designing an experiment. When you build an experiment to the limits, you give away the very important chance for a later experiment evolution.**

The acceleration of the catapult system is about 18 g₀ in average for about 280 ms, the peak value is about 30 g₀. The deceleration by the end of any drop is 25 g₀ in

average for about 200 ms (see chapter 4.3). The peak value is $< 50 g_0$ for < 11 ms. In order to keep your experiment operational over a longer campaigns period, it is recommended to design the hardware against higher acceleration forces (factor 2).

⚠ Important note: Don't use shock absorbers within the experimental setup. In general, industrial shock absorbers are designed against shock (e.g. < 11 ms duration; military-standards). The actual acceleration is of a quasi-steady type. Therefore industrial shock absorbers might lead to an amplification of accelerations as they delay deceleration of a body relative to the capsules deceleration. The deceleration of a body will be the smoothest the more rigid it is connected to the capsules structure. Damping is performed by the polystyrene grain inside the deceleration container.

Even though this acceleration forces appear to be strong, experience showed that this is not a serious problem. However, this forces need to be reflected on whenever designing an experiment. Note, that most manufacturers will not guarantee for a safe operation under these conditions. But this is mainly because they did not test their equipment under those conditions.

⚠ Important note: Especially for catapult experiments it is mandatory to design a stiff rigid mechanical setup which is able to withstand the acceleration forces without any displacement of the assembly parts. Cantilever beams or any kind of systems that might oscillate during the acceleration process must be avoided.

Masses and Dimensions of the Bremen Drop Capsule

Version	short	long	catapult
stringer length [mm]	1341	2107	1341
max. payload height [mm]	953	1718	953
total area of experiment-platform [m ²]	0.359		
base structure incl. batteries and CCS [kg]	122.8		
top lid plate incl. video transmission unit [kg]	32.9		30.2
pressurized cover incl. clamping rings and thermal isolation cover [kg]	38.5	61.1	38.5
4 stringer [kg]	36.8	57.4	36.8
nose cone incl. connection rod [kg]	4.6		10.2
1 experiment-platform incl. brackets [kg]	15.5		
capsule net weight [kg]	235.6	278.8	238.5
capsule gross weight [kg]	500		400*
max. payload mass [kg]	264.4	221.2	161.5

* actual limit, enhancement up to 500 kg in future depends on evolution progress

Tab. 1 Masses and Dimensions

For more detailed information about catapult capsules please contact the ZARM FAB staff.

2.4.1.1 Experiment-Platforms

Integration of experiments is made on specially designed sandwich-platforms of an aluminum / plywood / aluminum compound. These platforms can withstand the deceleration forces and serve for rapid damping of release induced oscillations. Experimental parts can be fixed safely on or underneath the platforms by the experimenter himself at his premise. It is even possible to saw wholes into the platform in case of large assemblies must penetrate a platform. Fig. 4 shows a platform drawing with its dimensions and the areas which can be modified by the

experimenter. **⚠ Even though the platform construction appears to be simple, it is not permitted to build platforms of your own.** This is for safety reasons as well as to ensure the drop tower environmental conditions being reproducible. Dependent on the agencies contracts, a different number of platforms is included in the campaign contract free of additional charge. Fig. 5 shows an example of a pre-integrated platform supporting a heavy combustion chamber. **⚠ Note: it is permitted to drill wholes into the platform but it is not permitted to open the outer contour (e.g. by sawing into the platform from outside).**

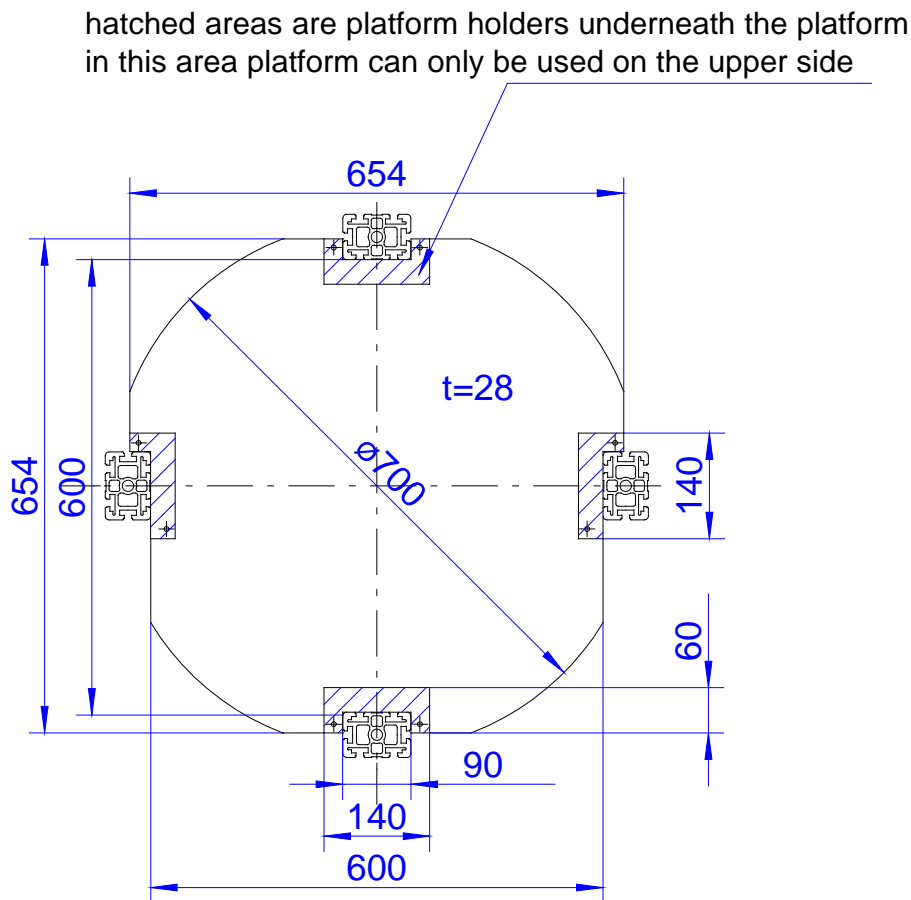

Fig. 4 Drop tower experiment platform

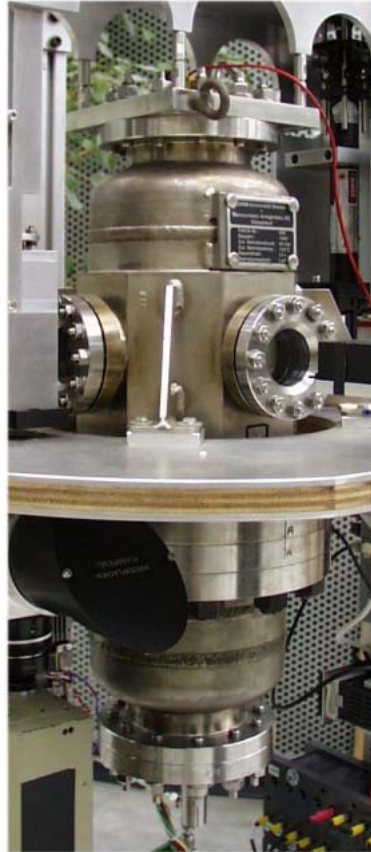

Fig. 5 Example for a heavy chamber mounted through a platform

2.4.2 The Drop Capsule, electrically

The 24 V experiment power is supplied from the capsule's rechargeable Experiment Battery or alternatively by the High Current External Power Supply (see: Special Equipment).

The onboard battery-pack is of the lead-gel type. The nominal capacity is 25 Ah. The experiment is connected to the battery-pack via the PDU.

2.4.2.1 Power Distribution Unit (PDU)

This unit provides nominal 24 V DC power to the experiment, during the evacuation period the battery is buffered with max 10 Amp. by the Battery Load Power Supply, which is disconnected about 1.5 min prior to the drop command. Six Output Channels can be switched via telecommand. The six channels are protected in three lines with

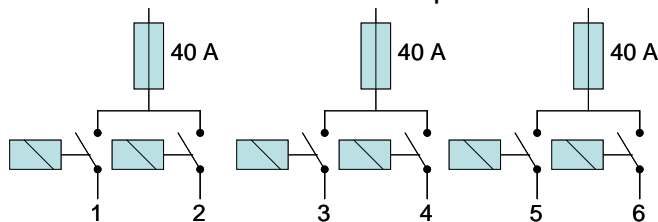

slow 40 A fuses each. This is only to protect the batteries against short circuits. The protection of user's hardware with appropriate fusing is the experimenters duty.

⚠ Important note: Experimental hardware directly connected to the power supply need to match the following limitations:

Operation Voltage Range: 22.6 V to 30 V DC
Max Current per Channel/ Pair: 40 Amp.

The actual voltage of the battery results from the initial charge status and the actual discharge as a function of time.

In all cases where input sensitive hardware is used, DC-DC converters are recommended.

All consumers must be grounded to one identical point on each platform.

2.4.2.2 Electromagnetic compatibility

Electromagnetic emission levels of the experiment should be as low as possible. It is in the customers own interest to reduce susceptibility and emissivity by following design guidelines:

- avoid ground loops
- separate alignment for power, data and switch commands
- twist and / or shield emissive or susceptible lines
- shield emissive or susceptible experiment components
- avoid sparks and rapid electric charge transitions

2.4.3 The Drop Capsule, electronically

2.4.3.1 Experiment Control

Experiment control is enabled via the Capsule Control System (CCS). The engagement of the CCS into experiment control is mandatory. The CCS operates like a storage-programmable logic controller including data handling and the telemetry /telecommand management. In cases where the performance of the CCS is not appropriate, e.g. in terms of sampling rate or resolution or communication interfaces, the customer is requested to implement the needed hardware into his setup. Triggering of the customer hardware (all mechanical or electronic elements) is foreseen to be done by the CCS.

The specially developed software package “Kapsel-Boden” (http://www.zarm.uni-bremen.de/fileadmin/images/droptower/downloads/Kapsel_Boden_Reference.pdf) is easy to use and enables the implementation of conditional logical operations related to all inputs and outputs of the CCS. This includes also the housekeeping data channels.

To automatize and control a drop capsule experiment, an “ExperimentVI” (http://www.zarm.uni-bremen.de/fileadmin/images/droptower/downloads/ExperimentVI_Reference.pdf) will be developed on site in close co-operation with the scientist. This VI (virtual instrument) will be implemented under the rules of National Instruments™ programming language G (see “G Reference Manual” of National Instruments™). Any hardware I/O is provided to ExperimentVI as global variables by the capsule program (Kapsel). Used globals includes all data and will be transmitted via Wireless-Lan to the ground program (Boden) where all acquired data can be permanently stored to the corresponding user account. For data files and global variables description see “Kapsel-Boden Reference” and “ExperimentVI Reference”.

As a first approach please keep in mind, that the interface to your experiment is the CCS and when you care for the electronic interfaces of your experiment matching the interface specifications given hereafter, you must not care on the program in advance. Also wiring between the experiment and the CCS will be done on-site.

2.4.3.2 The Capsule Control System (CCS)

After integration of the experiment into the mechanical structure, the experiment becomes connected to the CCS. The CCS is based upon a National Instruments™ PXI Chassis 1000B-DC with Real Time Controller 8145 RT equipped with PXI-6031E (Dev1), PXI-6527E (Dev2), PXI-6713 (Dev3) and a second PXI-6031E (Dev4). The CCS is depicted in Fig. 6.

Connection of experiment digital and analogue I/O channels to the CCS is performed via the interface board (Fig. 7, Fig. 8). Definition of in and out is from the CCS point of view. So “in” stands for signals from the experiment into the CCS and “out” stands for signals from the CCS towards the experiment.

The digital channels are for experiment control and display the status of digital elements (switches). The analog channels are for experiment- and housekeeping data acquisition. Analog out channels can also be used for experiment control (e.g. mass flow controllers).



Fig. 6 National Instruments PXI-1000B Real Time Capsule Control System

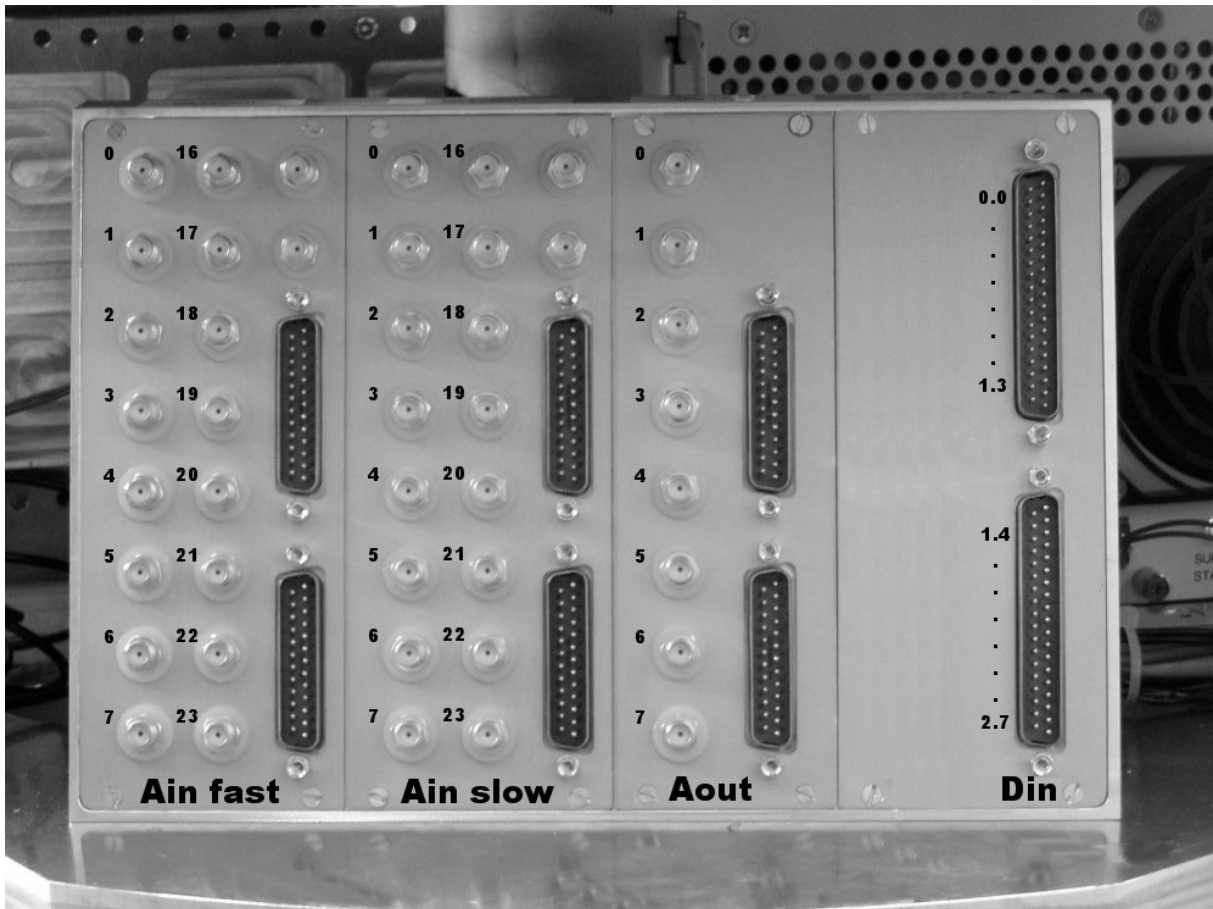

Fig. 7 Experiment Interface Board (Analog I/O and Digital in)

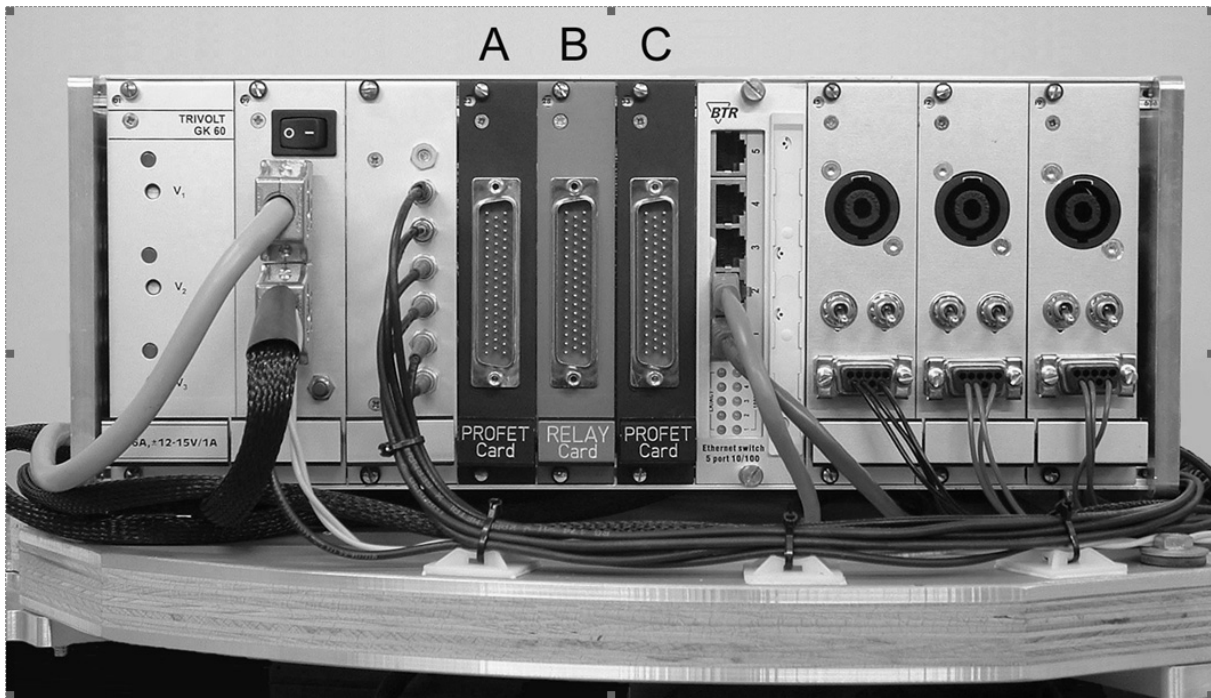

Fig. 8 Experiment Interface Board (Digital out and Power Distribution Unit)

The following table gives an overview over the different CCS-channels.

I/O Overview

	Digital			Analog		
	In	Out		In	Out	
Hardware (Device)	pxi6527 (Dev2)	pxi6527 (Dev2)	pxi6713 (Dev3)	pxi6031E (Dev1)	pxi6031E (Dev4)	pxi6713 (Dev3)
quantity	24	24	6	16	16	8
sampl.rate	100 Hz	10 Hz	10 Hz	100 S/s to 100 kS/s	1 to 99 S/s	max 100 Hz
connector	D-Sub 37 male	D-Sub 50 male	Neutrik Speakon	SMA female	SMA female	SMA female
electrical characteristics	TTL up to 24 V	Card dependent. See below	Solid State Relay max ratings: U=33 V, I=40 A	See below	See below	See below

Tab. 2 I/O channels overview

Digital Out

For digital out channels there are three Slots A, B, and C available (see Fig. 8). Slot C is reserved for a ProFet-TTL card, there is no other card possible. Slot A or B can be equipped with either a Relay-card or a ProFet-card. The interface card installation is experiment/ requirement dependent.

Slot/number of channels	Hardware	Dev/Port
A / 16	RelayCard, ProFet	Dev2/3.0-3.7, 4.0-4.7
B / 8	RelayCard, ProFet	Dev2/5.0-5.7
C / 16	ProFet-TTL	Dev1/0-7 Dev4/0-7

Relay Card

Relay alternate contact, max ratings: $U = 33V$, $I = 5A$.

Each channel is galvanic isolated by using optoelectronic coupler.

When connecting inductive loads, self-induction recuperation diodes must be installed.

A pico fuse (5A fast) is connected in series to the alternate contact. This protects the relay contact and the circuit.

ProFet Card

FET Output/Channel: $U_{max} = 65V$, $U_{min} = 5V$, $I_{max} = 5A$

Each channel is powered up by the V_{bb} -pin. The channels are galvanic isolated and protected by a self-induction recuperation diode. Furthermore each channel is protected against over current, over temperature and short circuits by an electronic fuse. This electronic fuse resets by switching off the power supply on pin V_{bb} . The connection to the PXI system is galvanic isolated by optoelectronic coupler. The "Low"-Level on each channel is max 0.3V.

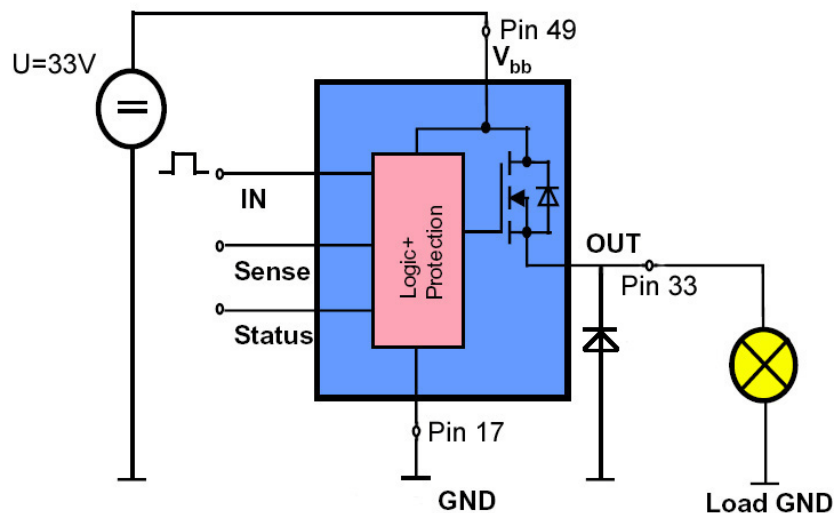

Fig. 9 Exemplary circuit diagram of a ProFet-channel

Digital Out D-Sub 50 male connector			
Channel-ID	6527A	6527A	6527A
	Relay: NC-Pin ProFet: GND	Relay: Alt-Pin ProFet: Vbb	Relay: NO-Pin ProFet: Out
3.0	17	49	33
3.1	16	48	32
3.2	15	47	31
3.3	14	46	30
3.4	13	45	29
3.5	12	44	28
3.6	11	43	27
3.7	10	42	26
4.0	9	41	25
4.1	8	40	24
4.2	7	39	23
4.3	6	38	22
4.4	5	37	21
4.5	4	36	20
4.6	3	35	19
4.7	2	34	18
Channel-ID	6527B	6527B	6527B
	Relay: NC-Pin ProFet: GND	Relay: Alt-Pin ProFet: Vbb	Relay: NO-Pin ProFet: Out
5.0	17	49	33
5.1	16	48	32
5.2	15	47	31
5.3	14	46	30
5.4	13	45	29
5.5	12	44	28
5.6	11	43	27
5.7	10	42	26

Tab. 3

Digital In

Digital inputs individually grounded.
Max. input voltage 28 VDC

Digital logic levels

Level	Min / V	Max / V
Low	0	1
high	2	28

Input current : max 8 mA/channel.
Isolation: 60 VDC channel-to-channel and from PXI ground.

Digital In D-Sub 37 male connector		
Channel-ID	6527C, +Pin	6527C, -Pin
0.0	1	20
0.1	2	21
0.2	3	22
0.3	4	23
0.4	5	24
0.5	6	25
0.6	7	26
0.7	8	27
1.0	9	28
1.1	10	29
1.2	11	30
1.3	12	31
Channel-ID	6527D, +Pin	6527D, -Pin
1.4	1	20
1.5	2	21
1.6	3	22
1.7	4	23
2.0	5	24
2.1	6	25
2.2	7	26
2.3	8	27
2.4	9	28
2.5	10	29
2.6	11	30
2.7	12	31

Tab. 4

Analog In

Two National Instruments™ PXI-6031E DAQ cards with overall 32 differential analog inputs. User signals must be sorted as to sampling rate of 100 Hz and faster and to smaller than 100 Hz and will be connected to the corresponding DAQ cards as described in the following tables.

Analog fast Input SMA female connectors	
Channel-ID	6031E (Dev1) SMA
0	0
1	1
2	2
3	3
4	4
5	5
6	6
7	7
16	8
17	9
18	10
19	11
20	12
21	13
22	14
23	15

Tab. 5

Analog slow Input SMA female connectors	
Channel-ID	6031E (Dev4) slow SMA
0	0
1	1
2	2
3	3
4	4
5	5
6	6
7	7
16	8
17	9
18	10
19	11
20	12
21	13
22	14
23	15

Tab. 6

Specifications

Number of channels

16 differential (100 S/s – 100 kS/s)

16 differential (1 S/s – 99 S/s)

Resolution

16 bit, 1 in 65536

Max. sampling rate (single channel)

100 kS/s

Input signal ranges

Gain Software- Selectable	Voltage Range (Software-Selectable)	
	Bipolar	Unipolar
1	+/- 10 V	0 to 10 V
2	+/- 5 V	0 to 5 V
5	+/- 2 V	0 to 2 V
10	+/- 1 V	0 to 1 V
20	+/- 0.5 V	0 to 0.5 V
50	+/- 0.2 V	0 to 0.2 V
100	+/- 0.1 V	0 to 0.1 V

Tab. 7

Overvoltage protection

+/- 25 V powered on
+/- 15 V powered off

For accuracy information refer to National Instruments™ “PXI E Series User Manual.pdf”.

Analog output

National Instruments™ PXI-6713E DAQ card with 8 voltage output channels. User signals will be connected to DAQ card Dev3 as described in the following table:

Analog Out SMA connector	
Channel ID	6713 SMA
0	0
1	1
2	2
3	3
4	4
5	5
6	6
7	7

Tab. 8

Specifications

Number of channels

8 voltage outputs

Resolution

12 bit, 1 in 4096

Ranges

+/- 10 V

Current drive

20 mA max. (sum of 8 channels)

Current drive

5 mA max. (single channel)

Protection

short-circuit to ground

Power – on state

0 V

For accuracy information refer to National Instruments™ “PXI E Series User Manual.pdf”.

3 Safety requirements

Even though the safety requirements are low, as compared to other micro-g facilities, some aspects are essential and to follow these rules is mandatory for a safe and successful operation. In general, these rules do not exceed those to be applied to the same research performed in a ground based laboratory.

 **It is the experimenters responsibility to care for a safe operation of his equipment. It is the experimenters duty to implement safeguards into the equipment. The experimenter shall examine the setup to identify potential hazards. The ZARM-FABmbH must become informed about any potential hazards identified by the experimenter in order to enable the installation of appropriate countermeasures.**

The rules to be applied are summarized below:

- Gaseous fuels and oxidizer must be stored in different containers. Ignitable pre-mixture storage is prohibited.
- There are no general pressure limits for gas reservoirs. But pressurized reservoirs used must be certified by the technical survey of the customers country. In case this does not exist or the request is inappropriate, the customer must be able to handover the technical standards related design calculations on request.
- If hazardous gases are used, an appropriate gas detector to monitor leakages must be part of the setup.
- The release of toxic, corrosive, explosive or bio-hazardous or else way contaminating matter into the capsule or to the outside of the capsule is prohibited. The customer is in any case requested to declare potential hazards for the drop tower crews' safety.
- Solenoid valves must be implemented into pressurized liquid circuits containing hazardous matter. The valves must be powerless closed. The switching power of the valves will be connected to the PDU with a g-switch. In case of CCS failure, the valves can that be closed by dropping the capsule.
- The use of mercury or unstable mercury containing mixtures is prohibited generally.
- Batteries must be of the dry- or gel-type. Liquid electrolytic batteries will be refused.
- The center of gravity of the setup shall be on the vertical axis of the capsule. Slight deviations from that can be compensated on-site through attaching passive counterbalance masses to the stringers. If this is impossible because of place or exceeding the maximum mass of the capsule, the experiment can be refused. Please care for in sum evenly distributed masses.
- Change of motion of masses during free-fall shall be avoided. If this cannot be achieved, accelerations must be compensated by accelerating counter-weights on- or around the identical axis. Consider the fact, that you don't know about the exact location of the COG of the complete capsule in no direction. In case of doubt, a pendulum test of the fully integrated capsule will be made on-site.
- Experiments that are mechanically weak and cannot be reinforced on-site will be refused. So, please care for your equipment matching the conditions given by the deceleration forces (see chapter 4).

- Any electric element (valves, detectors etc) subjected to hazards or hazard control must be connected to the CCS. As any computer, the CCS is not totally failsafe. Therefore the experiment shall be in general designed as failsafe as possible.

 **If potential hazards are not reflected above, it does not necessarily mean that these hazards do not exist. The „go“ is subjected to a final safety check after end of the integration. This may lead to a request for remedial measure. In case of doubt, you are strongly encouraged to soon search for discussion with us.**

4 Experiment Environment Conditions

4.1 Pressure Environment

The drop capsule is a gas tight pressure tested vessel, sealing the interior from the outer drop tube vacuum. The interior is kept on atmospheric conditions throughout the whole procedure.

The capsules inner pressure is permanently monitored as part of the housekeeping data measurements. Pressure deviation may result from a temperature shift due to differences of ambient temperature between the integration area and the top of the tube (seasonal variations)

In case of pressure rises due to outgassing experiments or high power consumption values, the pressure is released to the ambient during the evacuation process only.

Nominal Capsule Pressure: $p = 1.013 \text{ hPa}$
Pressure loss: $\Delta p < 1\% \text{ within } 3 \text{ h}$
Safety Values: $980 \text{ hPa} < p < 1.300 \text{ hPa}$

in case the pressure falls short of the minimum value due to leakages, the experiment procedure is aborted.

The outer drop tube residual pressure is an essential factor in determining the μg -quality. The drop can be initiated when the tube pressure is below 10 Pa. The actual values can be read from the tower data, monitored in the control room.

4.2 Thermal Environment

The temperature of the interior of the capsule is monitored.

The temperature in general is RT. During the evacuation period in winter, temperature can drop to 0 °C. For sensitive experiments the whole interior can be heated up to RT.

Experiments can be connected to a thermal liquid circuit. This circuit is connected to a thermostat outside of the tube. Through a closed loop regulation, temperature can be adjusted between -20 °C and +60 °C. The circuit is disconnected about 1.5 min prior to the drop command.

Technical data of the thermostat:

Forerun temperature:	-20 °C .. +60 °C
Liquid:	Glycole/Water-Mixture
Heating power:	max. 2 kW
Cooling power:	at +20 °C: 2.3 kW at -20 °C: 1.2 kW
Volume of bath:	19-27 l
max. pressure:	0.6 bar

An onboard heat exchanger with about 1 KW power (forerun temperature dependent) can be made available.

4.3 Accelerations

Accelerations are relevant in three aspects.

- a) Transition from 1g to 0g (drop mode) / Transition from approx. 30g to 0g (catapult mode)
- b) Residual accelerations
- c) Acceleration / deceleration forces

ad a) If experiment initiation is required to be prior to the drop, the experimenter is requested to keep in mind that the transition from 1g to 0g (drop mode) might be of disturbing effect to the experiment. The release mechanism has been designed and revised over the years in order to achieve a smooth transition. Nevertheless, for some experiments it might still be of relevance (e.g. for levitation systems, experiments with long relaxation times, hardware like interferometers that might become misaligned if not loaded by 1g).

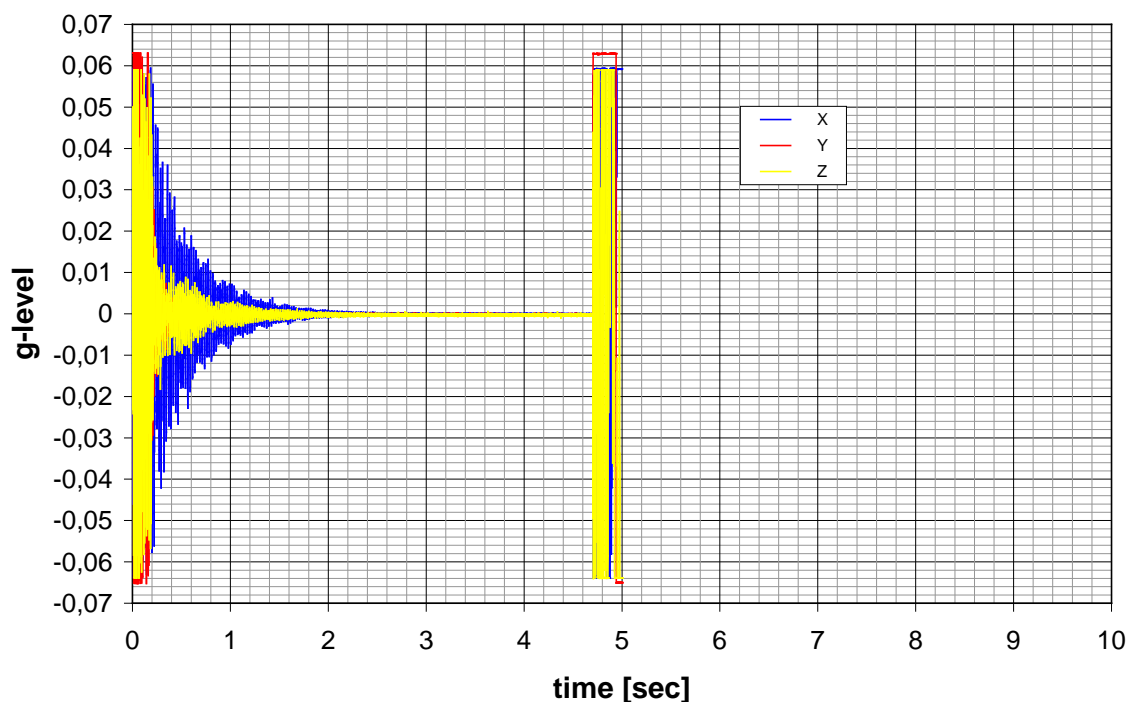

Fig. 10 Typical drop experiment, residual accelerations, Y is drop axis, X and Z are cross axes.

Note: The high sensitive acceleration sensors are overloaded at the beginning, after about 0.2 seconds they are within the measurement range

This accounts the more if the catapult is applied with an initial transition from 30g to 0g.

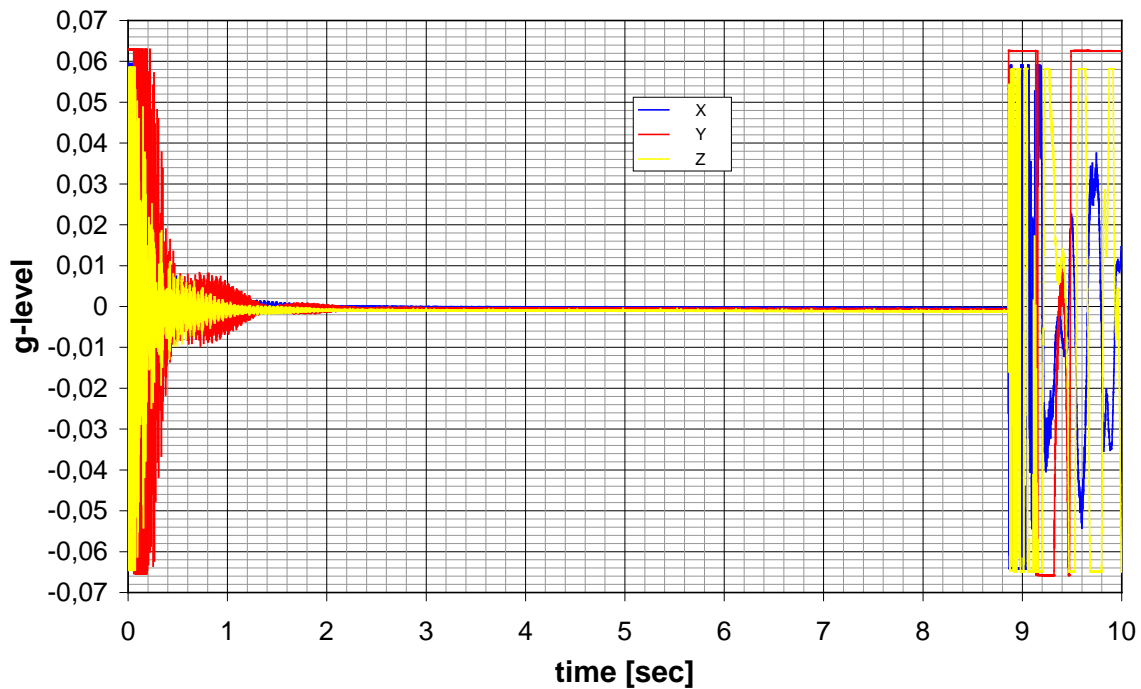

Fig. 11 Typical catapult launch, residual accelerations, Y is drop axis, X and Z are cross axes.

Note: The high sensitive acceleration sensors are overloaded at the beginning, after about 0.2 seconds they are within the measurement range

ad b) The residual accelerations (microgravity quality) during the flight are as low as 10^{-6} to 10^{-5} of g_0 . This is to the best values amongst the microgravity facilities. The following figure depicts the residual accelerations during the experiment. The data as well as those from the Fourier spectrum were grabbed during a drop of a capsule without experiment. The capsule was equipped with batteries, running CCS, data transmission system, sensor platform and platforms loaded with screwed steel plates of an experiment comparable mass. These data can serve as reference environment data.

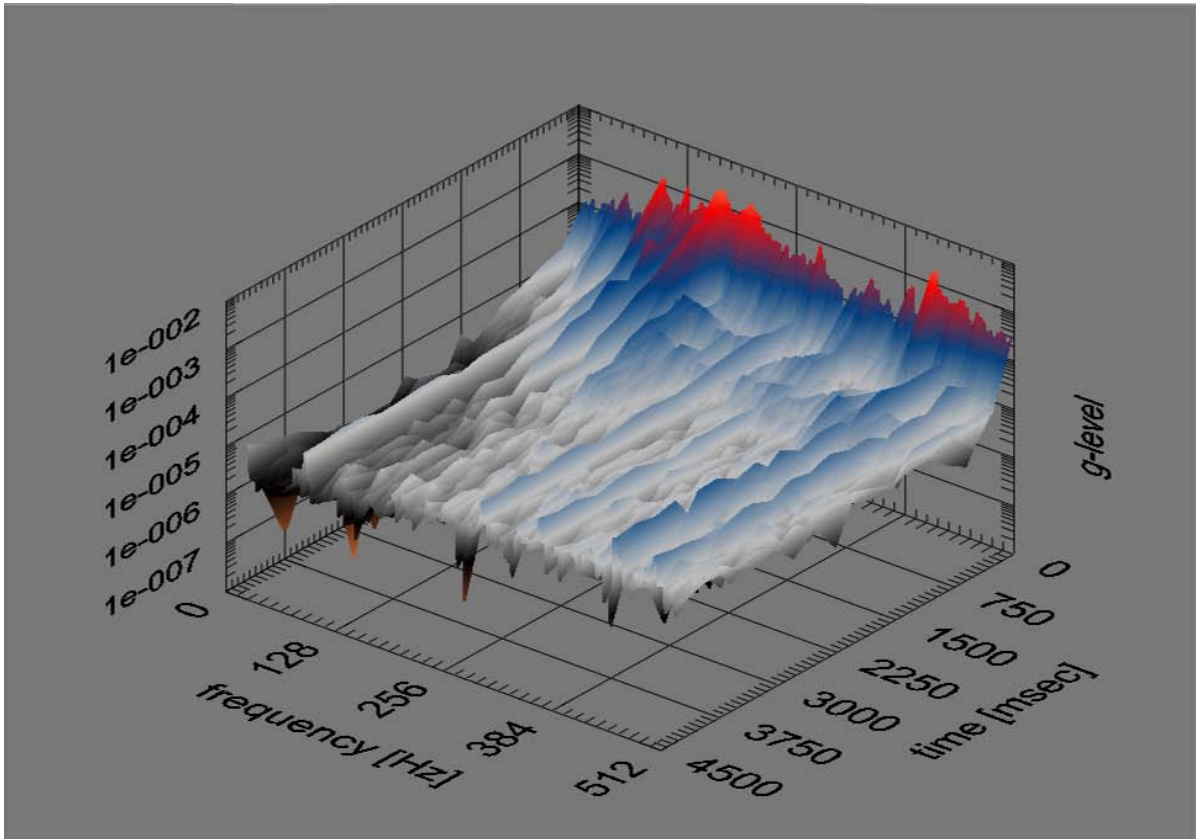

Fig. 12 Waterfall amplitude spectrum of drop axis, free fall (ref. Fig. 10)

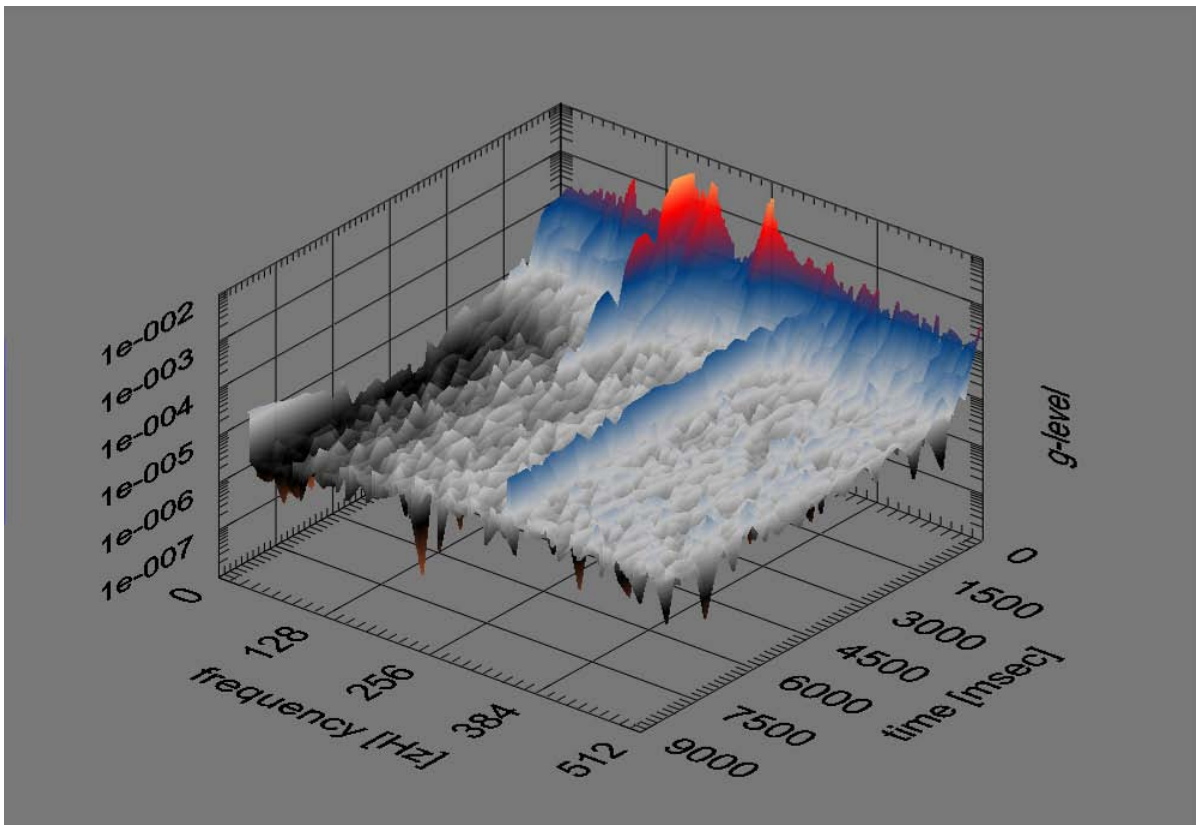

Fig. 13 Waterfall amplitude spectrum of drop axis, catapult launch (ref. Fig. 11)

As shown in the measurement curves above, the residual acceleration and damping rate during flight phase of a catapult experiment is not worse than in a drop experiment. An elaborate experimental setup is the most important criterion leading to a good microgravity environment!

ad c) The experimental hardware must be designed and mounted enabling to withstand the acceleration / deceleration forces. The following graphs depict typical acceleration / deceleration curves of Bremen drop tower. As can be seen (Fig. 15), the deceleration lasts for about 200 ms. The average value is $25 g_0$, the peak value is about $50 g_0$. For design purposes, these values must be handled as quasi-steady accelerations. The introduction of a safety factor of 2 is strongly recommended. Therefore the experiment shall be able to withstand acceleration up to $100 g_0$.

⚠ Important note: Even if these values appear to be high, the half-sine character of the curve prevent from industrial standard equipment to fail. Please keep in mind, that qualified equipment is not available at stores. All given shock resistance values are in accordance with military standards. This was tested against shock (<11 ms) and oscillations which is incomparable to quasi-steady accelerations. The drop tower acceleration / deceleration forces are of minor effect as compared to oscillatory accelerations of the same order of magnitude. In contrary, military standard approved equipment might fail as shock absorbers are often implemented. In the drop tower case, shock absorbers might lead to an amplification of accelerations. The best design is to fit all elements together (and to the platforms) as rigid as possible. No damping elements are recommended.

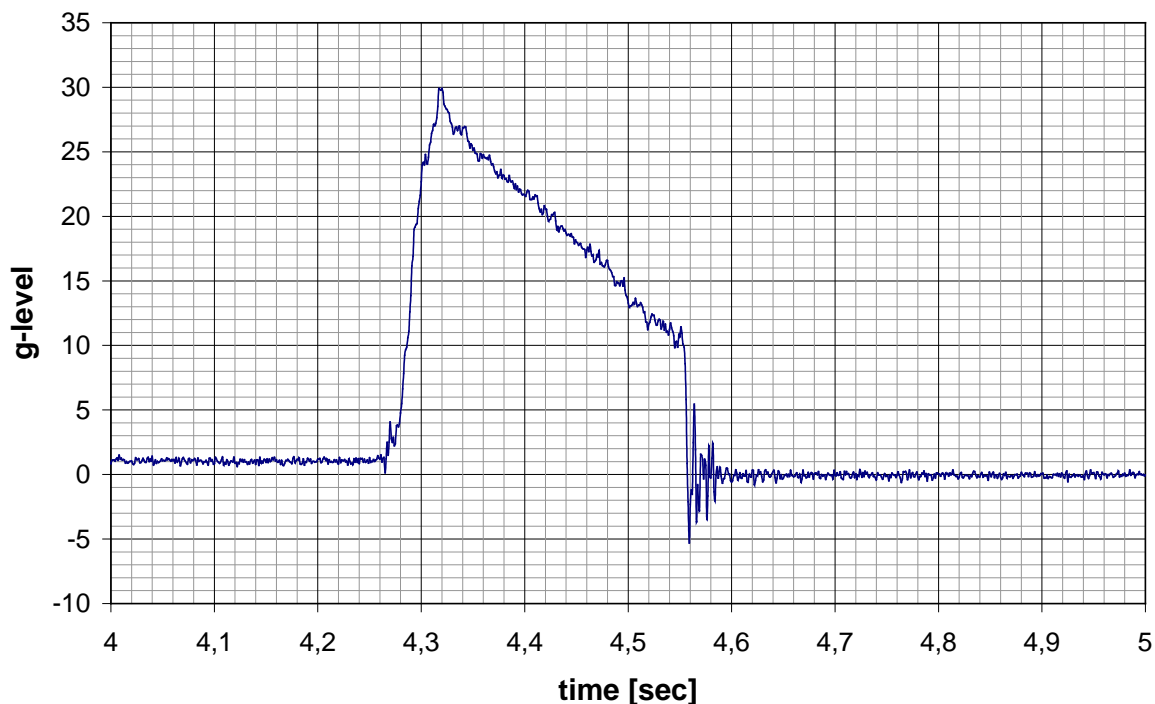

Fig. 14 Typical acceleration plot, capsule is launched by the catapult system
Note: The delay time of about 4 sec after initialization of launch

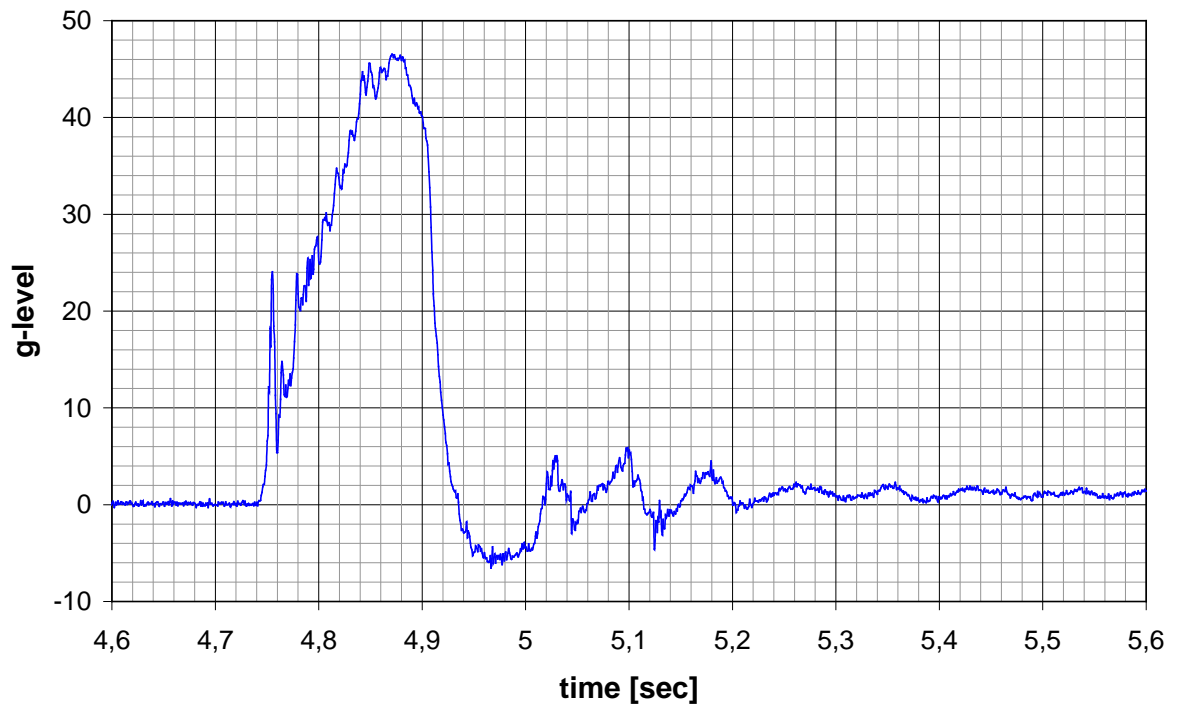

Fig. 15 Typical deceleration plot, capsule slow down inside the deceleration container

5 Special Equipment

In general, experiments are expected to be fully equipped with all necessary sensors. Mainly special equipment that cannot be expected to be made available by the experimenter can be hired temporarily (throughout a drop campaign) from ZARM-FABmbH. In any case, you need some equipment, you have not at hand,- ask us.

5.1 CCD-Cameras, VCR's, Lenses

Color CCD-cameras and problem-specific lenses can be made available onsite. The cameras are mainly objected to complement the experimental hardware if during integration or during the drop campaign additional optical access or data occur to be desirable. The cameras are of the CCIR-standard.

Recorders are of the DVCam™ standard as depicted.



Fig. 16 DVCam™ recorder and CCIR camera with zoom lens



Fig. 17 DVCam™ recorder, front panel



Fig. 18 DVCam™ recorder, rear panel

Two independent video channels can be transmitted to ground prior and during the experiment time. These data are stored in parallel onboard. The bandwidth of the transmitted data is standard video.

5.2 Digital High-Speed CMOS Imaging System

A digital High Speed Video System (*Photron Fastcam MC-2™*) can be offered. It is based on light sensitive CMOS imaging sensors and offers the following performance:

- Two remote camera heads (35mm x 35mm x 35mm; 90g; without lens)
- 512 x 512 pixel resolution
- 2000 f/s recording rate at full image resolution, for both camera heads and 4 s recording time
- 1000 f/s recording rate at full image resolution, for both camera heads and 8 s recording time
- up to 10.000 f/s with reduced image resolution (512 x 96 pixel)
- Global electronic shutter from 20ms to 6 μ s
- Color (24 Bit) or monochrome (8 Bit)
- Cameras precisely synchronized to an external source
- Lens mount: C-mount
- Remote camera heads with 3m cable allows easy positioning at hardly accessible space
- Processor unit (H: 195mm x W: 159mm x D: 130mm; 5kg)
- Live Video during recording, NTSC, PAL
- Ethernet camera control
- Start, End, Center and Manual Trigger Modes
- Saved formats: JPEG, AVI, TIFF, BMP, RAW, RAWW, PNG, FTIF

The live video output can be transmitted to ground prior and during the experiment time. The high-speed data are stored onboard. The bandwidth of the transmitted data is standard video.



Fig. 19 *Photron Fastcam MC2™* with dual camera head

5.3 Heating and Cooling Devices

Experiments can be connected to a thermal liquid circuit. This circuit is connected to a thermostat outside of the drop tube. Through a closed loop regulation, temperature can be adjusted between $-20\text{ }^{\circ}\text{C}$ and $+60\text{ }^{\circ}\text{C}$. The circuit is disconnected about 1.5 min prior to the drop command.

Technical data of the thermostat:

Forerun temperature:	$-20\text{ }^{\circ}\text{C}$.. $+60\text{ }^{\circ}\text{C}$
Liquid:	Glycole/Water-Mixture
Heating power:	max. 2 kW
Cooling power:	at $+20\text{ }^{\circ}\text{C}$: 2,3 kW at $-20\text{ }^{\circ}\text{C}$: 1,2 kW
Volume of bath:	19-27 l
max. pressure:	0,6 bar

A heat exchanger with about 1 KW power (forerun temperature dependent) can be made available

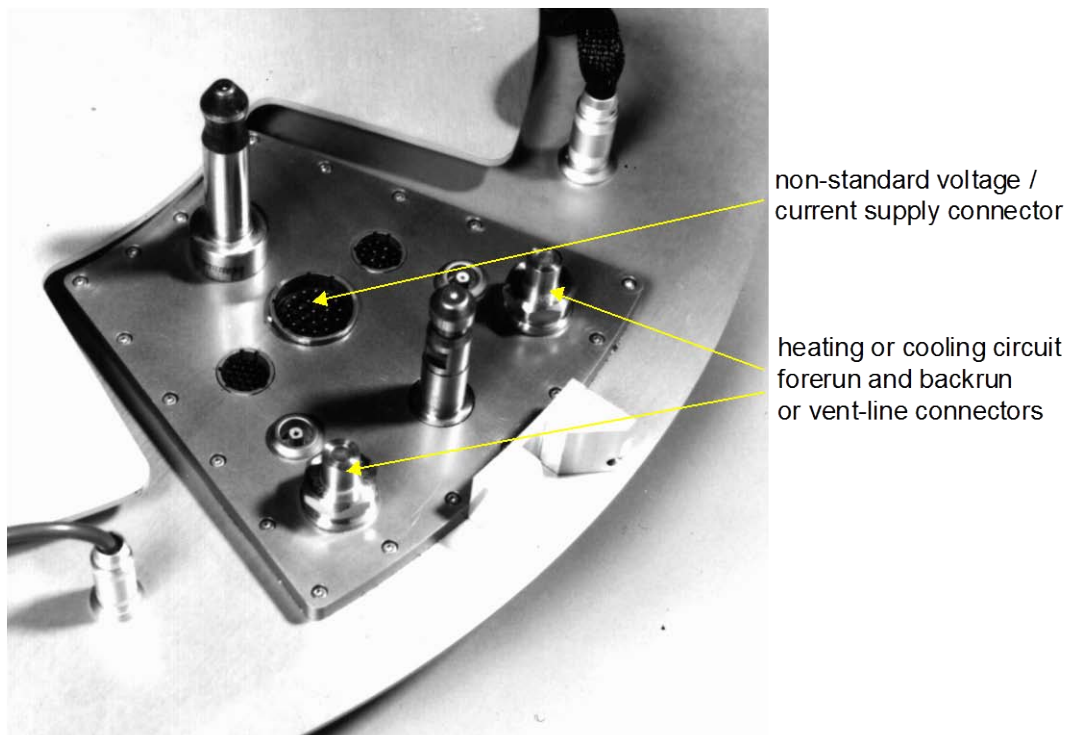

Fig. 20 Umbilical at the capsules' lid plate with connectors for various external media. The umbilical is automatically engaged and will be disengaged about 1.5 min prior to the release of the capsule.

5.4 Non-Standard Voltage-/ Current-Supply

One new feature is the High Current Power Supply, to be used as an external power supply providing max. 28 VDC with up to 100 A. Switching of current is performed with ramps. This power supply is disconnected from the capsule about 1.5 min prior to the drop command.

5.5 Vent-Line

Experiments releasing gases (e.g. from cryogenic devices or combustion exhausts) can be connected to a vent-line. The connector is located at the cover plate. The gases can from there be guided to the outside of the drop tube (alternative use of the connectors of the heating and cooling circuit up to 1.5 min prior to release of the capsule) or released to the ambient vacuum.

To avoid thruster effects during free-fall, the vent-line must be closed prior to release of the capsule.

During the free-fall, gases must be stored in onboard containers (delivered by the experimenter).

Cryogenic gases of non-contaminating nature or combustion exhaust gases that are free from particulates (soot, PIV-tracers) can be released to the inside of the capsule during free-fall.

5.6 Micro-g Centrifuge

Experiments, requesting data from accelerations between 1g and 0g can take use of a specially designed onboard micro-g centrifuge. The centrifuge in general consists of a rotating platform equipped with a number of slip-ring transducers for electrical power- and signal transmission between rotating platform and capsule.



Fig. 21 Image depicts the turntable loaded with several fish tanks with individual illumination and camera observation

Total height without experimental setup:	340 mm
Turntable diameter:	540 mm
Fixation:	T-slots 10*4mm, slot nut M5
Maximum load on turntable:	18kg
Revolutions:	0 ÷ 400 rpm

 The turntables rpm is freely programmable and controllable but in order to prevent the capsule from counter-rotating the rpm shall not be changed during free fall.

 In order to prevent the capsule from tumbling during free fall, the turntables load shall be balanced.

For electric connection of hardware elements 30 slip-ring transducers are available. Four of which are designed for coaxial (BNC) connections.

 Micro-g-centrifuge is not applicable for catapult operation.