

# Modern Microprocessors

## A 90 Minute Guide!

*Today's robots are very primitive, capable of understanding only a few simple instructions such as 'go left', 'go right' and 'build car'.*

— John Sladek

By Jason Robert Carey Patterson, last updated Aug 2012 (orig Feb 2001)

[Table of Contents](#)

WARNING: This article is meant to be informal and fun!

Okay, so you're a CS graduate and you did a hardware/assembly course as part of your degree, but perhaps that was a few years ago now and you haven't really kept up with the details of processor designs since then.

In particular, you might not be aware of some key topics that developed rapidly in recent times...

- pipelining (superscalar, OoO, VLIW, branch prediction, predication)
- multi-core & simultaneous multithreading (SMT, hyper-threading)
- SIMD vector instructions (MMX/SSE/AVX, AltiVec)
- caches and the memory hierarchy

Fear not! This article will get you up to speed *fast*. In no time you'll be discussing the finer points of in-order vs out-of-order, hyper-threading, multi-core and cache organization like a pro.

But be prepared – this article is brief and to-the-point. It pulls no punches and the pace is pretty fierce (really). Let's get into it...

### More Than Just Megahertz

The first issue that must be cleared up is the difference between clock speed and a processor's performance. *They are not the same thing*. Look at the results for processors of a few years ago (the late 1990s)...

		<i>SPECint95</i>	<i>SPECfp95</i>
195 MHz	MIPS R10000	11.0	17.0
400 MHz	Alpha 21164	12.3	17.2
300 MHz	UltraSPARC	12.1	15.5
300 MHz	Pentium-II	11.6	8.8
300 MHz	PowerPC G3	14.8	11.4
135 MHz	POWER2	6.2	17.6

A 200 MHz MIPS R10000, a 300 MHz UltraSPARC and a 400 MHz Alpha 21164 were all about the same speed at running most programs, yet they differed by a factor of two in clock speed. A 300 MHz Pentium-II was also about the same speed for many things, yet it was about half that speed for floating-point code such as scientific number crunching. A PowerPC G3 at that same 300 MHz was somewhat faster than the others for normal integer code, but still far slower than the top 3 for floating-point. At the other extreme, an IBM POWER2 processor at just 135 MHz matched the 400 MHz Alpha 21164 in floating-point speed, yet was only half as fast for normal integer programs.

How can this be? Obviously, there's more to it than just clock speed – it's all about how much work gets done in each clock cycle. Which leads to...

## Pipelining & Instruction-Level Parallelism

Instructions are executed one after the other inside the processor, right? Well, that makes it easy to understand, but that's not really what happens. In fact, that hasn't happened since the middle of the 1980s. Instead, several instructions are all *partially executing* at the same time.

Consider how an instruction is executed – first it is fetched, then decoded, then executed by the appropriate functional unit, and finally the result is written into place. With this scheme, a simple processor might take 4 cycles per instruction (CPI = 4)...

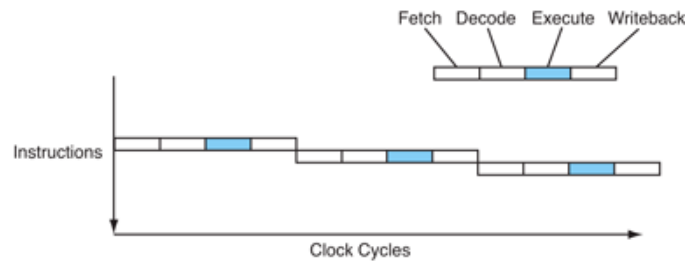

Figure 1 – The instruction flow of a sequential processor.

Modern processors overlap these stages in a *pipeline*, like an assembly line. While one instruction is executing, the next instruction is being decoded, and the one after that is being fetched...

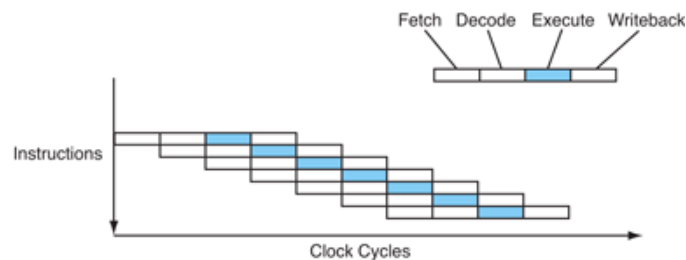

Figure 2 – The instruction flow of a pipelined processor.

Now the processor is completing 1 instruction every cycle (CPI = 1). This is a four-fold speedup without changing the clock speed at all. Not bad, huh?

From the hardware point of view, each pipeline stage consists of some combinatorial logic and possibly access to a register set and/or some form of high speed cache memory. The pipeline stages are separated by latches. A common clock signal synchronizes the latches between each stage, so that all the latches capture the results produced by the pipeline stages at the same time. In effect, the clock "pumps" instructions down the pipeline.

At the beginning of each clock cycle, the data and control information for a partially processed instruction is held in a pipeline latch, and this information forms the inputs to the logic circuits of the next pipeline stage. During the clock cycle, the signals propagate through the combinatorial logic of the stage, producing an output just in time to be captured by the next pipeline latch at the end of the clock cycle...

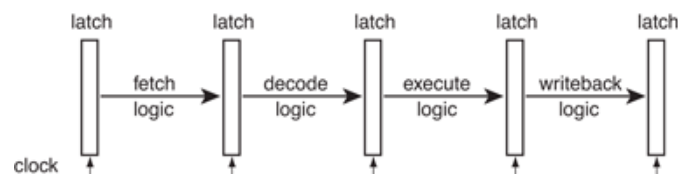

Figure 3 – A pipelined microarchitecture.

Since the result from each instruction is available after the execute stage has completed, the next instruction ought to be able to use that value immediately, rather than waiting for that result to be

committed to its destination register in the writeback stage. To allow this, forwarding lines called *bypasses* are added, going backwards along the pipeline...

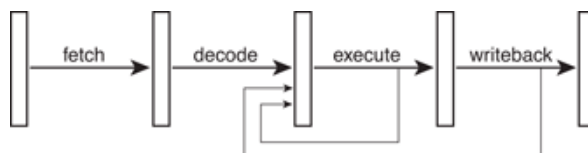

Figure 4 – A pipelined microarchitecture with bypasses.

Although the pipeline stages look simple, it is important to remember that the *execute* stage in particular is really made up of several different groups of logic (several sets of gates), making up different *functional units* for each type of operation that the processor must be able to perform...

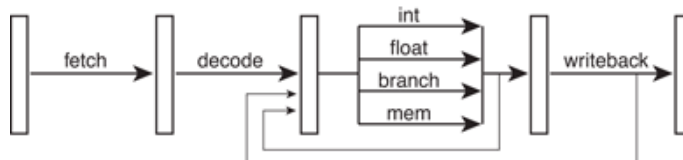

Figure 5 – A pipelined microarchitecture in more detail.

The early RISC processors, such as IBM's 801 research prototype, the MIPS R2000 (based on the Stanford MIPS machine) and the original SPARC (derived from the Berkeley RISC project), all implemented a simple 5 stage pipeline not unlike the one shown above (the extra stage is for memory access, placed after execute). At the same time, the mainstream 80386, 68030 and VAX processors worked sequentially using microcode (it's easier to pipeline a RISC because the instructions are all simple register-to-register operations, unlike x86, 68k or VAX). As a result, a SPARC running at 20 MHz was way faster than a 386 running at 33 MHz. Every processor since then has been pipelined, at least to some extent. A good summary of the original RISC research projects can be found in the [1985 CACM article](#) by David Patterson.

### Deeper Pipelines – Superpipelining

Since the clock speed is limited by (among other things) the length of the longest stage in the pipeline, the logic gates that make up each stage can be *subdivided*, especially the longer ones, converting the pipeline into a deeper super-pipeline with a larger number of shorter stages. Then the whole processor can be run at a *higher clock speed!* Of course, each instruction will now take more cycles to complete (latency), but the processor will still be completing 1 instruction per cycle (throughput), and there will be more cycles per second, so the processor will complete more instructions per second (actual performance)...

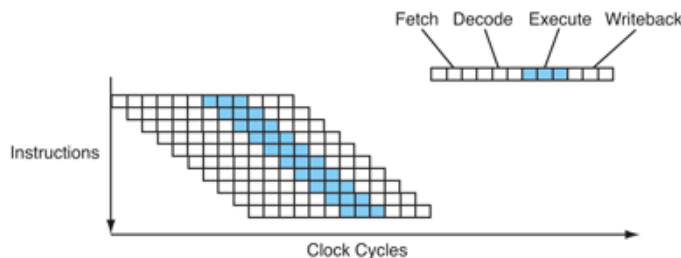

Figure 6 – The instruction flow of a superpipelined processor.

The Alpha architects in particular liked this idea, which is why the early Alphas had very deep pipelines and ran at such very high clock speeds for their era. Today, modern processors strive to keep the number of gate delays down to just a handful for each pipeline stage (about 12-25 gates deep (not total!) plus another 3-5 for the latch itself), and most have quite deep pipelines (7-12 in PowerPC G4e, 8+ in ARM11 & Cortex-A9, 10-15 in Athlon, 12+ in Pentium-Pro/II/III/M, 12-17 in Athlon 64/Phenom, 13+ in Cortex-A8, 14 in UltraSPARC-III/IV, 14+ in Core 2, 14-18+ in Core i\*2, 15 in Bobcat, 15-25 in Cortex-A15, 16 in Atom, 16+ in Core i, 16-25 in PowerPC G5, 18+ in Bulldozer, 20+ in Pentium-4, 31+ in Pentium-4E). The x86 processors generally have deeper pipelines than the RISCs because they need to do extra work to decode the complex x86 instructions (more on this

later). UltraSPARC-T1/T2/T3 are an exception to the deep pipeline trend (just 6 for UltraSPARC-T1 and 8-12 for T2/T3).

### Multiple Issue – Superscalar

Since the execute stage of the pipeline is really a bunch of different *functional units*, each doing its own task, it seems tempting to try to execute multiple instructions *in parallel*, each in its own functional unit. To do this, the fetch and decode/dispatch stages must be enhanced so that they can decode multiple instructions in parallel and send them out to the "execution resources"...

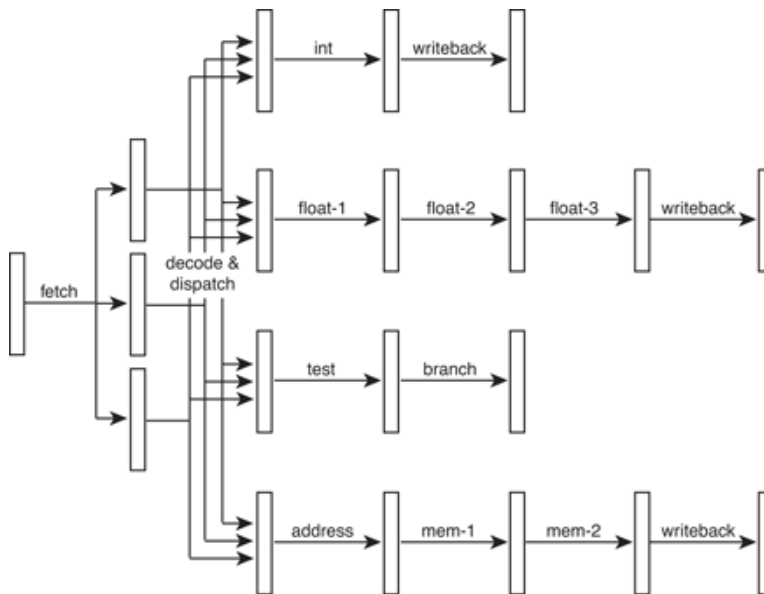

Figure 7 – A superscalar microarchitecture.

Of course, now that there are independent pipelines for each functional unit, they can even be different lengths. This allows the simpler instructions to complete more quickly, *reducing latency* (which we'll get to soon). There are also a bunch of bypasses within and between the various pipelines, but these have been left out of the diagram for simplicity.

In the above example, the processor could potentially execute 3 different instructions per cycle – for example one integer, one floating-point and one memory operation. Even more functional units could be added, so that the processor might be able to execute two integer instructions per cycle, or two floating-point instructions, or whatever the target applications could best use.

On a superscalar processor, the instruction flow looks something like...

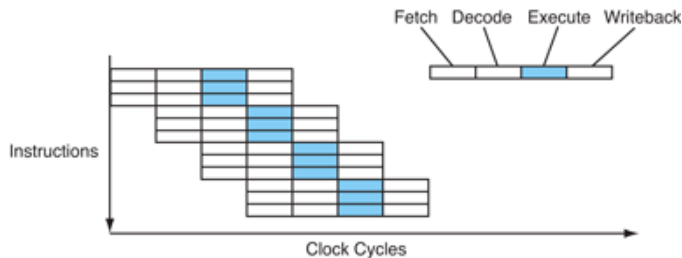

Figure 8 – The instruction flow of a superscalar processor.

This is great! There are now 3 instructions completing every cycle (CPI = 0.33, or IPC = 3). The number of instructions able to be issued or completed per cycle is called a processor's *width*.

Note that the issue-width is less than the number of functional units – this is typical. There must be more functional units because different code sequences have different mixes of instructions. The idea is to execute 3 instructions per cycle, but those instructions are not always going to be 1 integer, 1 floating-point and 1 memory operation, so more than 3 functional units are required.

The IBM POWER1 processor, the predecessor of PowerPC, was the first mainstream superscalar

processor. Most of the RISCs went superscalar soon after (SuperSPARC, Alpha 21064). Intel even managed to build a superscalar x86 – the original Pentium – however the complex x86 instruction set was a real problem for them (more on this later).

Of course, there's nothing stopping a processor from having both a deep pipeline and multiple instruction issue, so it can be both superpipelined and superscalar at the same time...

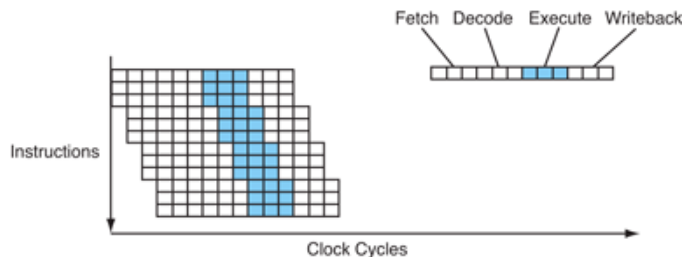

Figure 9 – The instruction flow of a superpipelined-superscalar processor.

Today, virtually every processor is a superpipelined-superscalar, so they're just called superscalar for short. Strictly speaking, superpipelining is just pipelining with a deeper pipe anyway.

The widths of current processors range from single-issue (ARM11, UltraSPARC-T1) through 2-issue (UltraSPARC-T2/T3, Cortex-A8 & A9, Atom, Bobcat) to 3-issue (Pentium-Pro/II/III/M, Athlon, Pentium-4, Athlon 64/Phenom, Cortex-A15) or 4-issue (UltraSPARC-III/IV, PowerPC G4e, Core 2, Core i, Core i\*2, Bulldozer) or 5-issue (PowerPC G5), or even 6-issue (Itanium, but it's a VLIW – see below). The exact number and type of functional units in each processor depends on its target market. Some processors have more floating-point execution resources (IBM's POWER line), others are more integer-biased (Pentium-Pro/II/III/M), some devote much of their resources towards SIMD vector instructions (PowerPC G4e), while most try to take the "balanced" middle ground.

### Explicit Parallelism – VLIW

In cases where backward compatibility is not an issue, it is possible for the *instruction set* itself to be designed to *explicitly* group instructions to be executed in parallel. This approach eliminates the need for complex dependency checking logic in the dispatch stage, which should make the processor easier to design (and easier to ramp up the clock speed over time, at least in theory).

In this style of processor, the "instructions" are really *groups* of little sub-instructions, and thus the instructions themselves are very long (often 128 bits or more), hence the name VLIW – *very long instruction word*. Each instruction contains information for multiple parallel operations.

A VLIW processor's instruction flow is much like a superscalar, except that the decode/dispatch stage is much simpler and only occurs for each group of sub-instructions...

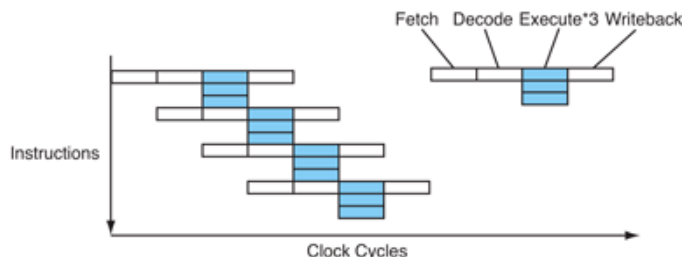

Figure 10 – The instruction flow of a VLIW processor.

Other than the simplification of the dispatch logic, VLIW processors are much like superscalar processors. This is especially so from a compiler's point of view (more on this later).

It is worth noting, however, that most VLIW designs are *not interlocked*. This means they do not check for dependencies between instructions, and often have no way of stalling instructions other than to stall the whole processor on a cache miss. As a result, the compiler needs to insert the appropriate number of cycles between dependent instructions, even if there are no instructions to fill the gap, by using *nops* (no-operations, pronounced "no-ops") if necessary. This complicates the compiler somewhat, because it is doing something that a superscalar processor normally does at runtime, however the extra code in the compiler is minimal and it saves precious resources on the

processor chip.

No VLIW designs have yet been commercially successful as mainstream CPUs, however Intel's IA64 architecture, which is still in production in the form of the Itanium processors, was once intended to be the replacement for x86. Intel chose to call IA64 an "EPIC" design, for "explicitly parallel instruction computing", but it was essentially a VLIW with clever grouping (to allow long-term compatibility) and predication (see below). The programmable shaders in many graphics processors (GPUs) are usually VLIW designs, although obviously they provide graphics-oriented instruction sets, and there's also Transmeta (see the x86 section, coming up soon).

## Instruction Dependencies & Latencies

How far can pipelining and multiple issue be taken? If a 5 stage pipeline is 5 times faster, why not build a 20 stage superpipeline? If 4-issue superscalar is good, why not go for 8-issue? For that matter, why not build a processor with a 50 stage pipeline which issues 20 instructions per cycle?

Well, consider the following two instructions...

```
a = b * c;
d = a + 1;
```

The second instruction *depends* on the first – the processor can't execute the second instruction until after the first has completed calculating its result. This is a serious problem, because instructions that depend on each other cannot be executed in parallel. Thus, multiple issue is impossible in this case.

If the first instruction was a simple integer addition then this might still be okay in a pipelined *single issue* processor, because integer addition is quick and the result of the first instruction would be available just in time to feed it back into the next instruction (using bypasses). However in the case of a multiply, which will take several cycles to complete, there is no way the result of the first instruction will be available when the second instruction reaches the execute stage just one cycle later. So, the processor will need to stall the execution of the second instruction until its data is available, inserting a *bubble* into the pipeline where no work gets done.

The number of cycles between when an instruction reaches the execute stage and when its result is available for use by other instructions is called the instruction's *latency*. The deeper the pipeline, the more stages and thus the longer the latency. So a very deep pipeline is not much more effective than a short one, because a deep one just gets filled up with bubbles thanks to all those nasty instructions depending on each other.

From a compiler's point of view, typical latencies in modern processors range from a single cycle for integer operations, to around 3-6 cycles for floating-point addition and the same or perhaps slightly longer for multiplication, through to over a dozen cycles for integer division.

Latencies for memory loads are particularly troublesome, in part because they tend to occur early within code sequences, which makes it difficult to fill their delays with useful instructions, and equally importantly because they are somewhat unpredictable – the load latency varies a lot depending on whether the access is a cache hit or not (we'll get to caches later).

It can be confusing when the word latency is used for related, but different, meanings. Here, I'm talking about the latency as seen by a compiler. Hardware engineers may think of latency as the total number of cycles required for execution (the length of the pipeline). So a hardware engineer might say that the instructions in a simple integer pipeline have a latency of 5 but a throughput of 1, whereas from a compiler's point of view they have a latency of 1 because their results are available for use in the very next cycle. The compiler view is the more common, and is generally used even in hardware manuals.

## Branches & Branch Prediction

Another key problem for pipelining is branches. Consider the following code sequence...

```
if (a > 5)
    b = c;
else
    b = d;
```

which compiles into something like...

```

    cmp a, 5    ; a > 5 ?
    ble L1
    mov c, b    ; b = c
    br L2
L1: mov d, b    ; b = d
L2: ...

```

Now consider a pipelined processor executing this code sequence. By the time the conditional branch at line 2 reaches the execute stage in the pipeline, the processor must have already fetched and decoded the next couple of instructions. But *which* instructions? Should it fetch and decode the *if* branch (lines 3 & 4) or the *else* branch (line 5)? It won't really know until the conditional branch gets to the execute stage, but in a deeply pipelined processor that might be several cycles away. And it can't afford to just wait – the processor encounters a branch every six instructions on average, and if it was to wait several cycles at every branch then most of the performance gained by using pipelining in the first place would be lost.

So the processor must make a *guess*. The processor will then fetch down the path it guessed and *speculatively* begin executing those instructions. Of course, it won't be able to actually commit (writeback) those instructions until the outcome of the branch is known. Worse, if the guess is wrong the instructions will have to be cancelled, and those cycles will have been wasted. But if the guess is correct the processor will be able to continue on at full speed.

The key question is *how* the processor should make the guess. Two alternatives spring to mind. First, the *compiler* might be able to mark the branch to tell the processor which way to go. This is called *static branch prediction*. It would be ideal if there was a bit in the instruction format in which to encode the prediction, but for older architectures this is not an option, so a convention can be used instead (such as backward branches are predicted to be taken while forward branches are predicted not-taken). More importantly, however, this approach requires the compiler to be quite smart in order for it to make the correct guess, which is easy for loops but might be difficult for other branches.

The other alternative is to have the processor make the guess *at runtime*. Normally, this is done by using an on-chip *branch prediction table* containing the addresses of recent branches and a bit indicating whether each branch was taken or not last time. In reality, most processors actually use two bits, so that a single not-taken occurrence doesn't reverse a generally taken prediction (important for loop back edges). Of course, this dynamic branch prediction table takes up valuable space on the processor chip, but branch prediction is so important that it's well worth it.

Unfortunately, even the best branch prediction techniques are sometimes wrong, and with a deep pipeline many instructions might need to be cancelled. This is called the *mispredict penalty*. The Pentium-Pro/II/III was a good example – it had a 12+ stage pipeline and thus a mispredict penalty of 10-15 cycles. Even with a clever dynamic branch predictor that correctly predicted an impressive 90% of the time, this high mispredict penalty meant about 30% of the Pentium-Pro/II/III's performance was lost due to mispredictions. Put another way, one third of the time the Pentium-Pro/II/III was not doing useful work but instead was saying "oops, wrong way". Modern processors devote ever more hardware to branch prediction in an attempt to raise the prediction accuracy even further, and reduce this cost, but even the best processors still lose quite a lot of performance due to branch mispredictions.

## Eliminating Branches with Predication

Conditional branches are so problematic that it would be nice to eliminate them altogether. Clearly, *if* statements cannot be eliminated from programming languages, so how can the resulting branches possibly be eliminated? The answer lies in the way some branches are used.

Consider the above example once again. Of the five instructions, two are branches, and one of those is an unconditional branch. If it was possible to somehow tag the *mov* instructions to tell them to execute only under some conditions, the code could be simplified...

```

    cmp a, 5    ; a > 5 ?
    mov c, b    ; b = c
    cmovle d, b ; if le, then b = d

```

Here, a new instruction has been introduced called *cmovle*, for "conditional move if less than or equal". This instruction works by executing as normal, but only commits itself if its condition is true. This is called a *predicated* instruction because its execution is controlled by a predicate (a true/false test).

Given this new predicated move instruction, two instructions have been eliminated from the code, and both were costly branches. In addition, by being clever and always doing the first *mov* then overwriting it if necessary, the parallelism of the code has also been increased – lines 1 and 2 can now be executed in parallel, resulting in a 50% speedup (2 cycles rather than 3). Most importantly, though, the possibility of getting the branch prediction wrong and suffering a large mispredict penalty has been eliminated.

Of course, if the blocks of code in the *if* and *else* cases were longer, then using predication would mean executing more instructions than using a branch, because the processor is effectively executing *both paths* through the code. Whether it's worth executing a few more instructions to avoid a branch is a tricky decision – for very small or very large blocks the decision is simple, but for medium-sized blocks there are complex tradeoffs which the optimizer must consider.

The Alpha architecture had a conditional move instruction from the very beginning. MIPS, SPARC and x86 added it later. With IA64, Intel went all-out and made almost every instruction predicated in the hope of dramatically reducing branching problems in inner loops, especially ones where the branches are unpredictable (such as compilers and OS kernels). Interestingly, the ARM architecture used in many phones and tablets was the first architecture with a fully predicated instruction set. This is even more intriguing given that the early ARM processors only had short pipelines and thus relatively small mispredict penalties.

## ***Instruction Scheduling, Register Renaming & OoO***

If branches and long latency instructions are going to cause bubbles in the pipeline(s), then perhaps those empty cycles can be used to do other work. To achieve this, the instructions in the program must be *reordered* so that while one instruction is waiting, other instructions can execute. For example, it might be possible to find a couple of other instructions from further down in the program and put them between the two instructions in the earlier multiply example.

There are two ways to do this. One approach is to do the reordering in hardware at runtime. Doing dynamic *instruction scheduling* (reordering) in the processor means the dispatch logic must be enhanced to look at groups of instructions and dispatch them out of order as best it can to use the processor's functional units. Not surprisingly, this is called *out-of-order execution*, or just OoO for short (sometimes written OOO or OOE).

If the processor is going to execute instructions out of order, it will need to keep in mind the dependencies between those instructions. This can be made easier by not dealing with the raw architecturally-defined registers, but instead using a set of *renamed* registers. For example, a store of a register into memory, followed by a load of some other piece of memory into the same register, represent different *values* and need not go into the same physical register. Furthermore, if these different instructions are mapped to different physical registers they can be executed in parallel, which is the whole point of OoO execution. So, the processor must keep a mapping of the instructions in flight at any moment and the physical registers they use. This process is called *register renaming*. As an added bonus, it becomes possible to work with a potentially larger set of real registers in an attempt to extract even more parallelism out of the code.

All of this dependency analysis, register renaming and OoO execution adds a lot of complex logic to the processor, making it harder to design, larger in terms of chip area, and more power hungry. The extra logic is particularly power hungry because those transistors are *always* working, unlike the functional units which spend at least some of their time idle (possibly even powered down). On the other hand, out-of-order execution offers the advantage that software need not be recompiled to get at least some of the benefits of the new processor's design (though typically not all).

Another approach to the whole problem is to have the *compiler* optimize the code by rearranging the instructions (called static, or compile-time, instruction scheduling). The rearranged instruction stream can then be fed to a processor with simpler in-order multiple-issue logic, relying on the compiler to "spoon feed" the processor with the best instruction stream. Avoiding the need for complex OoO logic should make the processor quite a lot easier to design, less power hungry and smaller, which means more cores (or extra cache) could be placed onto the same amount of chip area (more on this later).

The compiler approach also has some other advantages over OoO hardware – it can see further down the program than the hardware, and it can speculate down multiple paths rather than just one (a big issue if branches are unpredictable). On the other hand, a compiler can't be expected to be psychic, so it can't necessarily get everything perfect all the time. Without OoO hardware, the pipeline will stall when the compiler fails to predict something like a cache miss.

Most of the early superscalars were in-order designs (SuperSPARC, hyperSPARC, UltraSPARC-I/II, Alpha 21064 & 21164, the original Pentium). Examples of early OoO designs included the MIPS R10000, Alpha 21264 and to some extent the entire POWER/PowerPC line (with their reservation stations). Today, almost all high performance processors are out-of-order designs, with the notable



exceptions of UltraSPARC-III/IV and POWER6. Most low-power processors, such as ARM11, Cortex-A8 and Atom, are in-order designs because OoO logic consumes a lot of power for a relatively small performance gain.

## The Brainiac Debate

A question that must be asked is whether the costly out-of-order logic is really warranted, or whether compilers can do the task of instruction scheduling well enough without it. This is historically called the *brainiac vs speed-demon* debate. This simple (and fun) classification of design styles first appeared in a [1993 Microprocessor Report editorial](#) by Linley Gwennap, and was made widely known by Dileep Bhandarkar's [Alpha Implementations & Architecture](#) book.

*Brainiac* designs are at the smart-machine end of the spectrum, with lots of OoO hardware trying to squeeze every last drop of performance out of the code, even if it costs millions of logic transistors and tons of power to do it. In contrast, *speed-demon* designs are simpler and smaller, relying on a smart compiler and willing to sacrifice a little bit of instruction-level parallelism for the other benefits that simplicity brings. Historically, the speed-demon designs tended to run at higher clock speeds, precisely because they were simpler, hence the "speed-demon" name, but today that's no longer the case because clock speed is limited mainly by power and thermal issues.

Clearly, OoO hardware should make it possible for more instruction-level parallelism to be extracted, because things will be known at runtime that cannot be predicted in advance (cache misses, for example). On the other hand, a simpler in-order design will be smaller and use less power, which means you can place more small in-order cores onto the same chip as fewer, larger out-of-order cores. Which would you rather have: 4 powerful brainiac cores, or 8 simpler in-order cores?

Exactly which is the more important factor is currently open to hot debate. In general, it seems that both the benefits and the costs of OoO execution have been somewhat overstated in the past. In terms of cost, appropriate pipelining of the dispatch and register renaming logic allowed OoO processors to achieve clock speeds competitive with simpler designs by the late 1990s, and clever engineering has reduced the power overhead of OoO execution considerably in recent years, leaving only the chip area cost. This is a testament to some outstanding engineering by processor architects. Unfortunately, however, the effectiveness of OoO execution in dynamically extracting additional instruction-level parallelism has been disappointing, with only a relatively small improvement being seen, perhaps 20% or so. OoO execution has also been unable to deliver the degree of schedule-insensitivity originally hoped for, with recompilation still producing large speedups even on aggressive OoO processors.

When it comes to the brainiac debate, many vendors have gone down one path then changed their mind and switched to the other side...

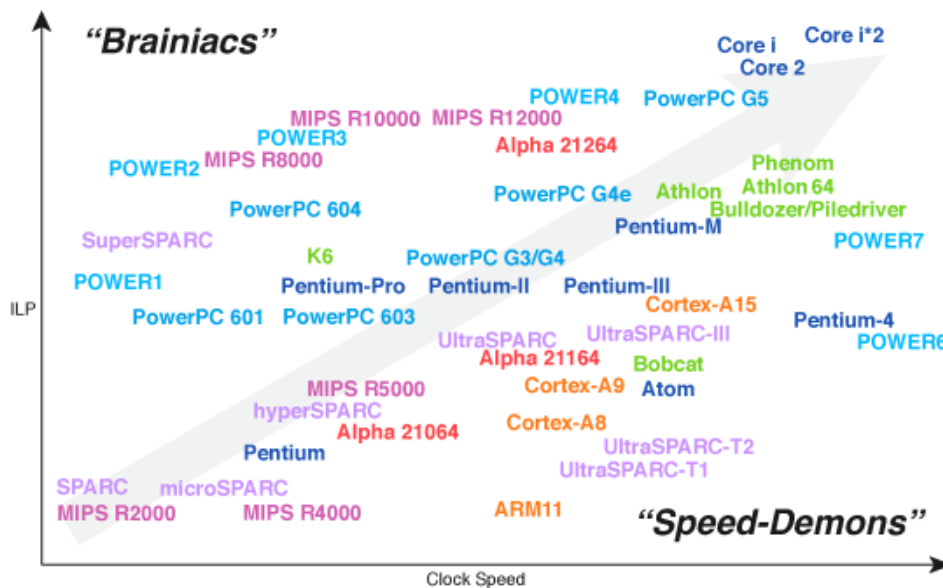

Figure 11 – Brainiacs vs speed-demons.

DEC, for example, went primarily speed-demon with the first two generations of Alpha, then changed to brainiac for the third generation. MIPS did similarly. Sun, on the other hand, went brainiac with their first superscalar then switched to speed-demon for more recent designs. The POWER/PowerPC

camp also gradually moved away from brainiac designs - over the years, although the reservation stations in all PowerPC designs do offer a degree of OoO execution between different functional units even if the instructions within each functional unit's queue are executed strictly in order.

Intel has been the most interesting of all to watch. Modern x86 processors have no choice but to be at least somewhat brainiac due to limitations of the x86 architecture (more on this soon), and the Pentium-Pro/II/III embraced that sentiment wholeheartedly. But then with the Pentium-4 Intel went about as speed-demon as possible for a decoupled x86 microarchitecture, and with IA64 Intel again bet solidly on the smart-compiler approach, with a simple but very wide design relying totally on static scheduling. Faced with the enormous power and heat issues of the Pentium-4, Intel then reversed its position once again and revived the older Pentium-Pro/II/III brainiac design to produce the Pentium-M and its Core successors.

No matter which route is taken, the key problem is still the same - normal programs just don't have a lot of fine-grained parallelism in them. A 4-issue superscalar processor requires four independent instructions to be available, with all their dependencies and latencies met, at every cycle. In reality this is virtually never possible, especially with load latencies of three or four cycles. Currently, real-world instruction-level parallelism for mainstream applications is limited to about 2 instructions per cycle at best. Certain types of applications do exhibit more parallelism, such as scientific code, but these are generally not representative of mainstream applications. There are also some types of code, such as pointer chasing, where even sustaining 1 instruction per cycle is extremely difficult. For those programs, the key problem is the memory system (which we'll get to later).

## **What About x86?**

So where does x86 fit into all this, and how have Intel and AMD been able to remain competitive through all of these developments in spite of an architecture that's now more than 30 years old?

While the original Pentium, a superscalar x86, was an amazing piece of engineering, it was clear that the big problem was the complex and messy x86 instruction set. Complex addressing modes and a minimal number of registers meant that few instructions could be executed in parallel due to potential dependencies. For the x86 camp to compete with the RISC architectures, they needed to find a way to "get around" the x86 instruction set.

The solution, invented independently (at about the same time) by engineers at both NexGen and Intel, was to *dynamically decode* the x86 instructions into simple, RISC-like micro-instructions, which can then be executed by a fast, RISC-style register-renaming OoO superscalar core. The micro-instructions are often called *uops* (short for micro-ops). Most x86 instructions decode into 1, 2 or 3 uops, while the more complex instructions require a larger number.

For these "decoupled" superscalar x86 processors, register renaming is absolutely critical due to the meager 8 registers of the x86 architecture in 32-bit mode (64-bit mode added another 8 registers). This differs strongly from the RISC architectures, where providing more registers via renaming only has a minor effect. Nonetheless, with clever register renaming, the full bag of RISC tricks become available to the x86 world, with the two exceptions of advanced static instruction scheduling (because the micro-instructions are hidden behind the x86 layer and thus are less visible to compilers) and the use of a large register set to avoid memory accesses.

The basic scheme works something like this...

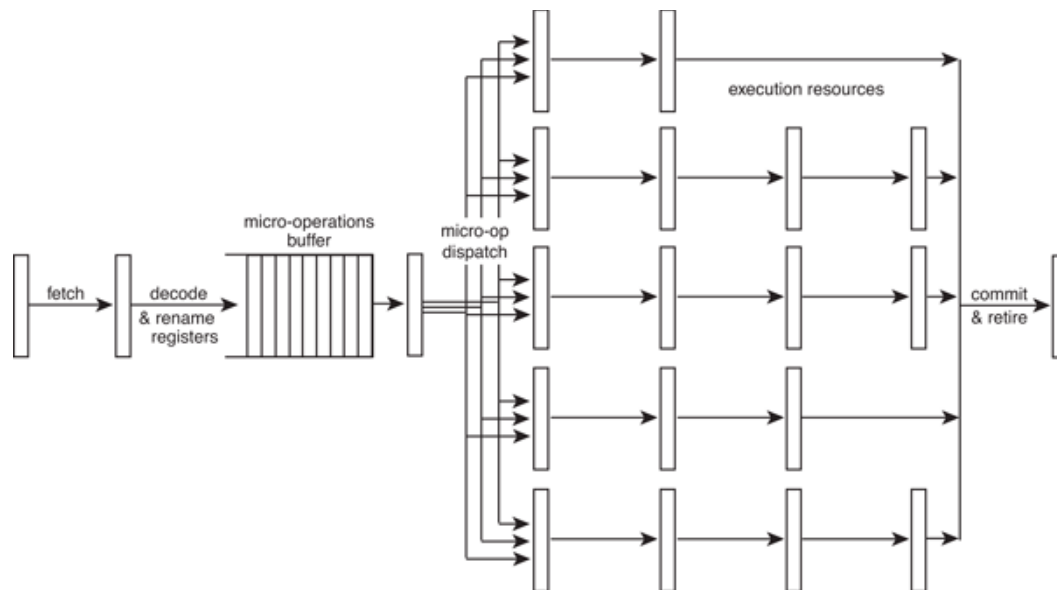

Figure 12 – A "RISCy x86" decoupled microarchitecture.

All recent x86 processors use this technique. Of course, they all differ in the exact design of their core pipelines, functional units and so on, just like the various RISC processors, but the fundamental idea of translating from x86 to internal micro-instructions is common to all of them.

One of the most interesting members of this RISC-style x86 group was the Transmeta Crusoe processor, which translated x86 instructions into an internal VLIW form, rather than internal superscalar, and used *software* to do the translation at runtime, much like a Java virtual machine. This approach allowed the processor itself to be a simple VLIW, without the complex x86 decoding and register renaming hardware of decoupled x86 designs, and without any superscalar dispatch or OoO logic either. The software-based x86 translation did reduce the system's performance compared to hardware translation (which occurs as additional pipeline stages and thus is almost free in performance terms), but the result was a very lean chip which ran fast and cool and used very little power. A 600 MHz Crusoe processor could match a then-current 500 MHz Pentium-III running in its low-power mode (300 MHz clock speed) while using only a fraction of the power and generating only a fraction of the heat. This made it ideal for laptops and handheld computers, where battery life is crucial. Today, of course, x86 processor variants designed specifically for low power use, such as the Pentium-M and its Core descendents, have made the Transmeta-style software-based approach unnecessary.

## Threads – SMT, Hyper-Threading & Multi-Core

As already mentioned, the approach of exploiting instruction-level parallelism through superscalar execution is seriously weakened by the fact that most normal programs just don't have a lot of fine-grained parallelism in them. Because of this, even the most aggressively brainiac OoO superscalar processor, coupled with a smart and aggressive compiler to spoon feed it, will still almost never exceed an average of about 2 instructions per cycle when running most real-world software, due to a combination of load latencies, cache misses, branching and dependencies between instructions. Issuing many instructions in the same cycle only ever happens for short bursts of a few cycles at most, separated by many cycles of executing low-ILP code, so peak performance is not even close to being achieved.

If additional independent instructions aren't available within the program being executed, there is another potential source of independent instructions – other running programs (or other threads within the same program). *Simultaneous multithreading* (SMT) is a processor design technique which exploits exactly this type of thread-level parallelism.

Once again, the idea is to fill those empty bubbles in the pipelines with useful instructions, but this time rather than using instructions from further down in the same program (which are hard to come by), the instructions come from *multiple threads* running at the same time, all on the *one processor core*. So, an SMT processor appears to the rest of the system as if it were multiple independent processors, just like a true multiprocessor system.

Of course, a true multiprocessor system also executes multiple threads simultaneously – but only one in each processor. This is also true for *multi-core* processors, which place two or more processor cores onto a single chip, but are otherwise no different from traditional multiprocessor systems. In

contrast, an SMT processor uses just one *physical* processor core to present two or more *logical* processors to the system. This makes SMT much more efficient than a multi-core processor in terms of chip space, fabrication cost, power usage and heat dissipation. And of course there's nothing preventing a multi-core implementation where each core is an SMT design.

From a hardware point of view, implementing SMT requires duplicating all of the parts of the processor which store the "execution state" of each thread – things like the program counter, the architecturally-visible registers (but not the rename registers), the memory mappings held in the TLB, and so on. Luckily, these parts only constitute a tiny fraction of the overall processor's hardware. The really large and complex parts, such as the decoders and dispatch logic, the functional units, and the caches, are all shared between the threads.

Of course, the processor must also keep track of which instructions and which rename registers belong to which threads at any given point in time, but it turns out that this only adds a small amount to the complexity of the core logic. So, for the relatively cheap design cost of around 10% more logic in the core (and an almost negligible increase in total transistor count and final production cost), the processor can execute several threads simultaneously, hopefully resulting in a substantial increase in functional unit utilization and instructions-per-clock (and thus overall performance).

The instruction flow of an SMT processor looks something like...

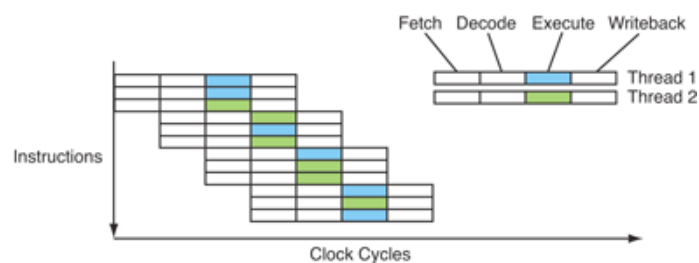

**Figure 13 – The instruction flow of an SMT processor.**

This is really great! Now that we can fill those bubbles by running multiple threads, we can justify adding more functional units than would normally be viable in a single-threaded processor, and really go to town with multiple instruction issue. In some cases, this may even have the side effect of improving single-thread performance (for particularly ILP-friendly code, for example).

So 20-issue here we come, right? Unfortunately, the answer is no.

SMT performance is a tricky business. First, the whole idea of SMT is built around the assumption that either lots of programs are simultaneously executing (not just sitting idle), or if just one program is running, it has *lots of threads all executing* at the same time. Experience with existing multiprocessor systems shows that this isn't always true. In practice, at least for desktops, laptops and small servers, it is rarely the case that several different programs are actively executing at the same time, so it usually comes down to just the one task that the machine is currently being used for.

Some applications, such as database systems, image & video processing, audio processing, 3D graphics rendering and scientific code, do have obvious high-level (course-grained) parallelism available and easy to exploit, but unfortunately even many of these applications have not been written to make use of multiple threads in order to exploit multiple processors. In addition, many of the applications which are inherently parallel in nature are primarily limited by memory bandwidth, not by the processor (eg: image & video processing, audio processing, most scientific code), so adding a second thread or processor won't help them much – unless memory bandwidth is also dramatically increased (we'll get to the memory system soon). Worse yet, many other applications such as web browsers, multimedia design tools, language interpreters, hardware simulations and so on, are simply not inherently parallel enough to make effective use of multiple processors.

On top of this, the fact that the threads in an SMT design are all *sharing* just one processor core, and just one set of caches, has major performance downsides compared to a true multiprocessor (or multi-core). Within the pipelines of an SMT processor, if one thread saturates just one functional unit which the other threads need, it effectively stalls all of the other threads, even if they only need relatively little use of that unit. Thus, balancing the progress of the threads becomes critical, and the most effective use of SMT is for applications with highly variable code mixtures (so that the threads don't constantly compete for the same hardware resources). Also, competition between the threads for cache space may produce worse results than letting just one thread have all the cache space available – particularly for applications where the critical working set is highly cache-size sensitive, such as hardware simulators/emulators, virtual machines and high quality video encoding (with a large motion prediction window).

The bottom line is that without care, and even with care for some applications, SMT performance can actually be *worse* than single-thread performance and traditional context switching between threads. On the other hand, applications which are limited primarily by memory latency (but not memory bandwidth), such as database systems and 3D graphics rendering, *benefit dramatically* from SMT, since it offers an effective way of using the otherwise idle time during cache misses (we'll cover caches later). Thus, SMT presents a very complex and application-specific performance picture. This also makes it a difficult challenge for marketing – sometimes almost as fast as two "real" processors, sometimes more like two really lame processors, sometimes even worse than one processor, huh?

The Pentium-4 was the first processor to use SMT, which Intel calls "hyper-threading". Its design allowed for 2 simultaneous threads (although earlier revisions of the Pentium-4 had the SMT feature disabled due to bugs). Speedups from SMT on the Pentium-4 ranged from around -10% to +30% depending on the application(s). Subsequent Intel designs then eschewed SMT during the transition back to the brainiac designs of the Pentium-M and Core 2, along with the transition to multi-core. Many other SMT designs were also cancelled around the same time (Alpha 21464, UltraSPARC-V), and for a while it almost seemed as if SMT was out of favor, before it finally made a comeback with POWER5, a 2-thread SMT design as well as being multi-core (2 threads per core times 2 cores per chip = 4 threads per chip). Intel's Core i and Core i\*2 are also 2-thread SMT, as is the low-power Atom x86 processor. A typical quad-core Core i processor is thus an 8 thread chip. Sun was the most aggressive of all on the thread-level parallelism front, with UltraSPARC-T1 (aka: "Niagara") providing 8 simple in-order cores each with 4-thread SMT, for a total of 32 threads on a single chip. This was subsequently increased to 8 threads per core in UltraSPARC-T2, and then 16 cores in UltraSPARC-T3, for a whopping 128 threads!

## **More Cores or Wider Cores?**

Given SMT's ability to convert thread-level parallelism into instruction-level parallelism, coupled with the advantage of better single-thread performance for particularly ILP-friendly code, you might now be asking why anyone would ever build a multi-core processor when an equally wide (in total) SMT design would be superior.

Well unfortunately it's not quite as simple as that. As it turns out, very wide superscalar designs scale very badly in terms of both chip area and clock speed. One key problem is that the complex multiple-issue dispatch logic scales somewhere between quadratically and exponentially with the issue-width. That is, the dispatch logic of a 5-issue processor is almost twice as big as a 4-issue design, with 6-issue being 4 times as big, 7-issue 8 times and so on. In addition, a very wide superscalar design requires highly multi-ported register files and caches. Both of these factors conspire to not only increase size, but also to massively increase the amount of wiring at the circuit-design level, placing serious limits on the clock speed. So a 10-issue core would actually be *both larger and slower* than two 5-issue cores, and our dream of a 20-issue SMT design isn't really viable due to circuit design limitations.

Nevertheless, since the benefits of both SMT and multi-core depend so much on the nature of the target application(s), a broad spectrum of designs might still make sense with varying degrees of SMT and multi-core. Let's explore some possibilities...

Today, a "typical" SMT design implies both a wide execution core and OoO execution logic, including multiple decoders, the large and complex superscalar dispatch logic and so on. Thus, the size of a typical SMT core is quite large in terms of chip area. With the same amount of chip space it would be possible to fit *several* simpler, single-issue, in-order cores (either with or without basic SMT). In fact, it may be the case that as many as half a dozen small, simple cores could fit within the chip area taken by just one modern OoO superscalar SMT design!

Now, given that both instruction-level parallelism and thread-level parallelism suffer from diminishing returns (in different ways), and remembering that SMT is essentially a way to convert TLP into ILP, but also remembering that wide superscalar OoO designs scale very non-linearly in terms of chip area (and design complexity), the obvious question is where is the sweet spot? How wide should the cores be made to reach a good balance between ILP and TLP? Right now, many different approaches are being explored...

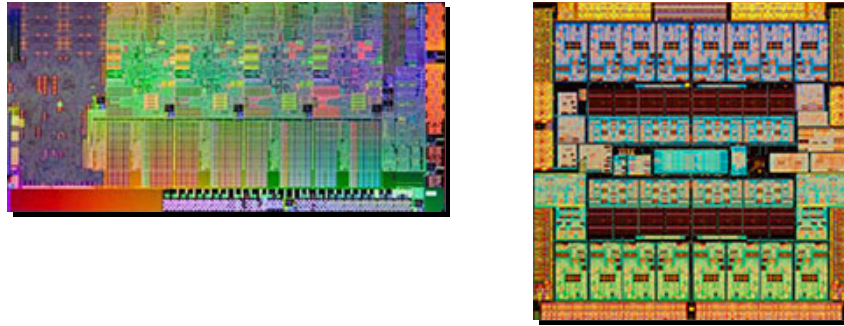

**Figure 14 – Design extremes: Core i\*2 "Sandy Bridge" vs UltraSPARC-T3 "Niagara 3".**

At one extreme we have processors like Intel's Core i\*2 "Sandy Bridge" (above left), consisting of four large, wide, 4-issue, out-of-order, aggressively brainiac cores (along the top, with shared L3 cache below) each running 2 threads for a total of 8 "fast" threads. At the other end of the spectrum, Sun's UltraSPARC-T3 "Niagara 3" (above right) contains 16 much smaller, simpler, 2-issue in-order cores (top and bottom with shared L2 cache towards the center) each running 8 threads, for a massive 128 threads in total, though these threads are considerably slower than those of the Core i\*2. Both chips contain around 1 billion transistors and are drawn approximately to scale above. Note just how much smaller the simple, in-order cores really are.

Which is the better approach? Alas, there's no simple answer here – once again it's going to depend very much on the application(s). For applications with lots of active but memory-latency-limited threads (eg: database systems, 3D graphics rendering), more simple cores would be better because the big/wide cores spend most of their time waiting for memory anyway. For most applications, however, there simply are not enough threads active to make this viable, and the performance of just a single thread is much more important, so a design with fewer but bigger, wider, more brainiac cores is more appropriate.

Of course, there are also a whole range of options between these two extremes that have yet to be fully explored. IBM's POWER7, for example, takes the middle ground with an 8 core, 4-thread SMT design with moderately but not overly aggressive OoO execution hardware. AMD's Bulldozer design uses a more innovative approach, with a shared, SMT-style front-end for each pair of cores feeding a back-end with unshared, multi-core-style integer execution units but shared, SMT-style floating-point units, blurring the lines between SMT and multi-core. Who knows, perhaps in the future we might even see *asymmetric* designs, with one or two big, wide, brainiac cores plus a large number of smaller, narrower, simpler cores. Just imagine trying to optimize code for that! IBM's Cell processor was arguably the first such design, although the small, simple cores in Cell were not instruction-set compatible with the large main core, and acted more like special-purpose coprocessors.

## **Data Parallelism – SIMD Vector Instructions**

In addition to instruction parallelism, there is another source of parallelism in many programs – data parallelism. Rather than looking for ways to execute groups of instructions in parallel, the idea is to look for ways to make one instruction apply to a group of values in parallel.

This is sometimes called SIMD parallelism (single instruction, multiple data). More often, it's called *vector processing*. Supercomputers used to use vector processing a lot, with very long vectors, because the types of scientific programs which are run on supercomputers are quite amenable to vector processing.

Today, however, vector supercomputers have long since given way to multiprocessor designs where each processing unit is a commodity CPU. So why revive vector processing?

In many situations, especially in imaging, video and multimedia applications, a program needs to execute the same instruction for a *small group* of related values, usually a short vector (a simple structure or small array). For example, an image processing application might want to add groups of 8-bit numbers, where each 8-bit number represents one of the red, green, blue or alpha (transparency) values of a pixel...

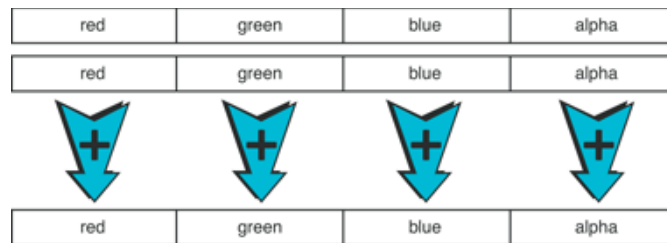

**Figure 15 – A SIMD vector addition operation.**

What's happening here is exactly the same operation as a 32-bit addition, except that every 8th carry is not being propagated. Also, it might be desirable for the values not to wrap to zero once all 8 bits are full, and instead to hold at 255 as a maximum value in those cases (called saturation arithmetic). In other words, every 8th carry is not carried across but instead triggers an all-ones result. So, the vector addition operation shown above is really just a modified 32-bit add.

From the hardware point of view, adding these types of vector instructions is not terribly difficult – existing registers can be used and in many cases the functional units can be shared with existing integer or floating-point units. Other useful packing and unpacking instructions can also be added, for byte shuffling and so on, and a few predicate-like instructions for bit-masking etc. With some thought, a small set of vector instructions can enable some impressive speedups.

Of course, there's no reason to stop at 32 bits. If there happen to be some 64-bit registers, which architectures usually have for floating-point (at least), they could be used to provide 64-bit vectors, thereby doubling the parallelism (SPARC VIS and x86 MMX did this). If it is possible to define entirely new registers, then they might as well be even wider (SSE added 8 new 128-bit registers, later increased to 16 registers in 64-bit mode, then widened to 256 bits with AVX, while PowerPC AltiVec provided a full set of 32 new 128-bit registers from the start, in keeping with PowerPC's more separated design style where even the branch instructions have their own registers). An alternative to widening the registers is to use pairing, where each pair of registers is treated as a single operand by the SIMD vector instructions (ARM NEON does this, with its registers usable both as 32 64-bit registers or as 16 128-bit registers). Naturally, the data in the registers can also be divided up in other ways, not just as 8-bit bytes – for example as 16-bit integers for high quality image processing, or as floating-point values for scientific number crunching. With AltiVec, for example, it is possible to execute a 4-way parallel floating-point multiply-add as a single, fully pipelined instruction.

For applications where this type of data parallelism is available and easy to extract, SIMD vector instructions can produce amazing speedups. The original target applications were primarily in the area of image and video processing, however suitable applications also include audio processing, speech recognition, some parts of 3D graphics rendering and many types of scientific programs. For other types of applications, such as compilers and database systems, the speedup is generally much smaller, perhaps even nothing at all.

Unfortunately, it's quite difficult for a compiler to automatically make use of vector instructions when working from normal source code, except in trivial cases. The key problem is that the way programmers write programs tends to serialize everything, which makes it difficult for a compiler to prove that two given operations are independent and can be done in parallel. Progress is slowly being made in this area, but at the moment programs must basically be rewritten by hand to take advantage of vector instructions (except for simple array-based loops in scientific code).

Luckily, however, rewriting just a small amount of code in key places within the graphics and video/audio libraries of your favorite operating system has a widespread effect across many applications. Today, most OSs have enhanced their key library functions in this way, so that virtually all multimedia and 3D graphics applications do make use of these highly effective vector instructions. Chalk up yet another win for abstraction!

Almost every architecture has now added SIMD vector extensions, including SPARC (VIS), x86 (MMX/SSE/AVX), PowerPC (AltiVec) and ARM (NEON). Only relatively recent processors from each architecture can execute some of these new instructions, however, which raises backward compatibility issues, especially on x86 where the SIMD instructions evolved somewhat haphazardly (3DNow!, MMX, SSE, SSE2, SSE3, SSE4, AVX).

## **Caches & The Memory Hierarchy**

As mentioned earlier, latency is a big problem for pipelined processors, and latency is especially bad for loads from memory, which make up about a quarter of all instructions.

Loads tend to occur near the beginning of code sequences (basic blocks), with most of the other



instructions depending on the data being loaded. This causes all the other instructions to stall, and makes it difficult to obtain large amounts of instruction-level parallelism. Things are even worse than they might first seem, because in practice most superscalar processors can still only issue one, or at most two, memory instructions per cycle.

The core problem with memory access is that building a fast memory system is very difficult because of fixed limits, like the speed of light. These impose delays while a signal is transferred out to RAM and back. Nothing can change this fact of nature – we must learn to work around it.

For example, access latency for main memory, even using a modern SDRAM with a CAS latency of 5, will typically be around 15 cycles of the *memory system clock* – 1 to send the address to the chipset (north bridge), 1 more to get it to the DIMM, RAS-to-CAS delay of 5 (assuming a page miss), CAS latency of 5, another 1 to get the data to the output buffer of the DIMM, 1 to send the data back to the chipset, and a final 1 to send the data up to the processor (or E-cache). On a multiprocessor system, even more bus cycles may be required to support cache coherency.

Assuming a typical 400 MHz SDRAM memory system (DDR2-800), and assuming a 2.0 GHz processor, this makes  $15 \times 5 = 75$  cycles of the *CPU clock* to access main memory! Yikes, you say! And it gets worse – a 2.4 GHz processor would take it to 90 cycles, a 2.8 GHz processor to 105 cycles, and even if the memory system was increased to 666 MHz (DDR3-1333, with CAS latency slipping to 9 in the process), a 3.3 GHz processor would still wait 115 cycles, and a 4.0 GHz processor a staggering 138 cycles to access main memory!

Furthermore, although a DDR SDRAM memory system transfers *data* on both the rising and falling edges of the clock signal (ie: at "double data rate"), the true clock speed of the memory system is still only half that, and it is the true clock speed which applies for control signals. So the latency of a DDR memory system is the same as a non-DDR system, even though the bandwidth is doubled (more on the difference between bandwidth and latency later).

Also note that a small portion of memory latency (2 of the 15 bus cycles) involves the transfer of data between the processor and the chipset on the motherboard. One way to reduce this is to dramatically increase the speed of the *frontside bus* (FSB) between the processor and the chipset (eg: 800 MHz QDR in Pentium-4, 1.25 GHz DDR in PowerPC G5). An even better approach is to integrate the memory controller directly onto the processor chip, which allows the 2 *bus* cycles to be converted into much faster *processor* cycles instead. The UltraSPARC-III and Athlon 64 were the first mainstream processors to do this, and now all modern designs feature on-chip memory controllers, although Intel were late to do so and only integrated the memory controller into their CPUs starting with Core i & i\*2.

Unfortunately, both DDR memory and on-chip memory controllers are only able to do so much – and memory latency continues to be a major problem. This problem of the large and widening gap between the processor and memory is sometimes called the *memory wall*. It was at one time the single most important problem facing hardware engineers, though today the problem has eased considerably because processor clock speeds are no longer climbing at the rate they previously did due to power and heat constraints.

Nonetheless, memory latency is still a *huge* problem.

Modern processors try to solve this problem with *caches*. A cache is a small but fast type of memory located on or near the processor chip. Its role is to keep copies of small pieces of main memory. When the processor asks for a particular piece of main memory, the cache can supply it much more quickly than main memory would be able to – if the data is in the cache.

Typically, there are small but fast "primary" level-1 (L1) caches on the processor chip itself, inside each core, usually around 8k-64k in size, with a larger level-2 (L2) cache further away but still on-chip (a few hundred KB to a few MB), and possibly an even larger and slower L3 cache etc. The combination of the on-chip caches, any off-chip external cache (E-cache) and main memory (DRAM) together form a *memory hierarchy*, with each successive level being larger but slower than the one before it. At the bottom of the memory hierarchy, of course, is the virtual memory system (paging/swapping), which provides the illusion of an almost infinite amount of main memory by moving pages of RAM to and from hard drive storage (which is even slower again, by a large margin).

The word cache is pronounced like "cash"... as in "a cache of weapons" or "a cache of supplies". It means a place for hiding or storing things. It is **not** pronounced "ca-shay" or "kay-sh".

It's a bit like working at a desk in a library... You might have two or three books open on the desk itself. Accessing them is fast (you can just look), but you can't fit more than a couple on the desk at the same time – and even if you could, accessing 100 books laid out on a huge desk would take longer because you'd have to walk between them. Instead, in the corner of the desk you might have a pile of a dozen more books. Accessing them is slower, because you have to reach over, grab one and open it up. Each time you open a new one, you also have to put one of the books already on the



desk back into the pile to make room. Finally, when you want a book that's not on the desk, and not in the pile, it's very slow to access because you have to get up and walk around the library looking for it. However the size of the library means you have access to thousands of books, far more than could ever fit on your desk.

The amazing thing about caches is that they work *really* well – they effectively make the memory system seem almost as fast as the L1 cache, yet as large as main memory. A modern primary (L1) cache has a latency of just 2 to 4 processor cycles, which is dozens of times faster than accessing main memory, and modern primary caches achieve hit rates of around 90% for most applications. So 90% of the time, accessing memory only takes a couple of cycles!

Caches can achieve these seemingly amazing hit rates because of the way programs work. Most programs exhibit *locality* in both time and space – when a program accesses a piece of memory, there's a good chance it will need to re-access the same piece of memory in the near future (temporal locality), and there's also a good chance that it will need to access other nearby memory in the future as well (spatial locality). Temporal locality is exploited by merely keeping recently-accessed data in the cache. To take advantage of spatial locality, data is transferred from main memory up into the cache in blocks of a few dozen bytes at a time, called a *cache block*.

From the hardware point of view, a cache works like a two column table – one column is the memory address and the other is the block of data values (remember that each cache line is a whole block of data, not just a single value). Of course, in reality the cache need only store the necessary higher-end part of the address, since lookups work by using the lower part of the address to index the cache. When the higher part, called the *tag*, matches the tag stored in the table, this is a *hit* and the appropriate piece of data can be sent to the CPU...

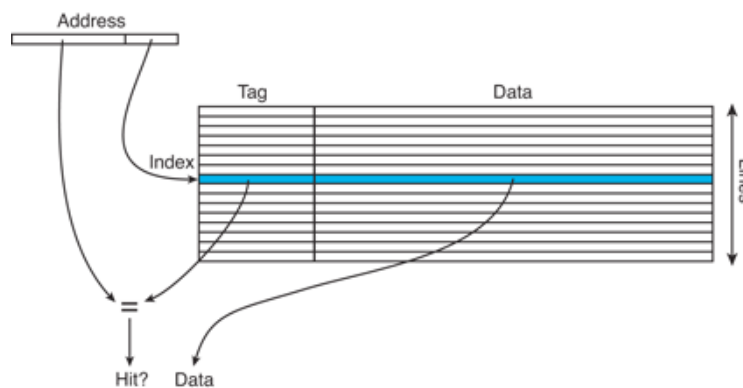

Figure 16 – A cache lookup.

It is possible to use either the physical address or the virtual address to do the cache lookup. Each has pros and cons (like everything else in computing). Using the virtual address might cause problems because different programs use the same virtual addresses to map to different physical addresses – the cache might need to be flushed on every context switch. On the other hand, using the physical address means the virtual-to-physical mapping must be performed as part of the cache lookup, making every lookup slower. A common trick is to use virtual addresses for the cache indexing but physical addresses for the tags. The virtual-to-physical mapping (TLB lookup) can then be performed in parallel with the cache indexing so that it will be ready in time for the tag comparison. Such a scheme is called a *virtually-indexed physically-tagged cache*.

The sizes and speeds of the various levels of cache in modern processors are absolutely crucial to performance. The most important by far is the primary L1 data cache. Some processors go for small data caches (Pentium-Pro/II/III, Pentium-4E and Bulldozer have 16k D-caches, earlier Pentium-4s and UltraSPARC-T1/T2/T3 are even smaller at just 8k), most have settled on 32k as the sweet spot, and a few are larger at 64k (Athlon, UltraSPARC-III/IV, Athlon 64/Phenom). For such caches, load latency is usually 3 cycles but occasionally shorter (2 cycles in UltraSPARC-III/IV, Pentium-4 & UltraSPARC-T1/T2/T3) or longer (4 cycles in Pentium-4E, Core i & i\*2, Cortex-A9 & A15, Bulldozer). Increasing the load latency by a cycle can seem like a minor change but is actually a serious hit to performance, and is something rarely noticed or understood by end users. For normal, everyday pointer-chasing code, a processor's load latency is a major factor in real-world performance.

Most modern processors also have a large second or third level of on-chip cache, usually shared between all cores. This cache is also very important, but its size sweet spot depends heavily on the type of application being run and the size of that application's active *working set*. The difference between 2 MiB of L3 cache and 8 MiB will be barely measurable for some applications, while for others it will be enormous. Given that the relatively small L1 caches already take up to half of the chip area for many modern processor cores, you can imagine how much area a large L2 or L3 cache

would take, yet this is still probably the best use for the high transistor budgets allowed by modern chip fabrication technology. Usually, the large L2/L3 cache is so large that it's clearly visible in chip photographs, standing out as a relatively clean, repetitive structure against the more "messy" logic transistors of the cores and memory controller.

## Cache Conflicts & Associativity

Ideally, a cache should keep the data that is most likely to be needed in the future. Since caches aren't psychic, a good approximation of this is to keep the most recently used data.

Unfortunately, keeping *exactly* the most recently used data would mean that data from *any* memory location could be placed into *any* cache line. The cache would thus contain exactly the most recently used  $n$  KB of data, which would be great for exploiting locality but unfortunately is *not* suitable for allowing fast access – accessing the cache would require checking *every* cache line for a possible match, which would be very slow for a modern cache with thousands of lines.

Instead, a cache usually only allows data from any particular address in memory to occupy one, or at most a handful, of locations within the cache. Thus, only one or a handful of checks are required during access, so access can be kept fast (which is the whole point of having a cache in the first place). This approach does have a downside, however – it means the cache doesn't store the absolutely best set of recently accessed data, because several different locations in memory will all map to the *same one location* in the cache. When two such memory locations are wanted at the same time, such a scenario is called a *cache conflict*.

Cache conflicts can cause "pathological" worst-case performance problems, because when a program repeatedly accesses two memory locations which happen to map to the same cache line, the cache must keep storing and loading from main memory and thus suffering the long main memory latency on each access (up to 100 cycles or more, remember!). This type of situation is called thrashing, since the cache is not achieving anything and is simply getting in the way – despite obvious temporal locality and reuse of data, the cache is unable to exploit the locality offered by this particular access pattern due to limitations of its simplistic mapping between memory locations and cache lines.

To address this problem, more sophisticated caches are able to place data in a small number of different places within the cache, rather than just a single place. The number of places a piece of data can be stored in a cache is called its *associativity*. The word associativity comes from the fact that cache lookups work by association – that is, a particular address in memory is associated with a particular location in the cache (or set of locations for a set-associative cache).

As described above, the simplest and fastest caches allow for only one place in the cache for each address in memory – each piece of data is simply mapped to  $address \% size$  within the cache by simply looking at the lower bits of the address (as in the above diagram). This is called a *direct mapped* cache. Any two locations in memory whose addresses are the same for the lower address bits will map to the same cache line in a direct mapped cache, causing a cache conflict.

A cache which allows data to occupy one of two locations based on its address is called 2-way *set-associative*. Similarly, a 4-way set-associative cache allows for 4 possible locations for any given piece of data. Set-associative caches work much like direct mapped ones, except there are several tables, all indexed in parallel, and the tags from each table are compared to see whether there is a match for any one of them...

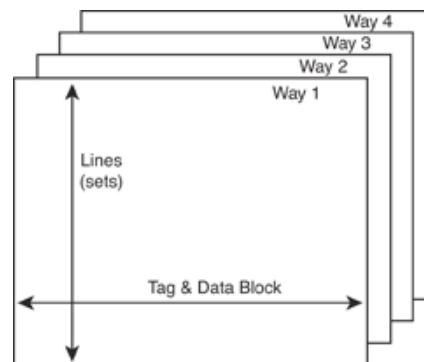

Figure 17 – A 4-way set-associative cache.

Each table, or *way*, may also have marker bits so that only the line of the least recently used way is evicted when a new line is brought in (or perhaps some faster approximation of that ideal).

Usually, set-associative caches are able to avoid the problems that occasionally occur with direct mapped caches due to unfortunate cache conflicts. Adding even more ways allows even more conflicts to be avoided. Unfortunately, the more highly associative a cache is, the slower it is to access, because there are more comparisons to perform during each access. Even though the comparisons themselves are performed in parallel, additional logic is required to select the appropriate hit, if any, and the cache may also need to update the marker bits appropriately within each way. More chip area is also required, because relatively more of the cache's data is consumed by tag information rather than data blocks, and extra datapaths are needed to access each individual way of the cache in parallel. Any and all of these factors may negatively affect access time. Thus, a 2-way set-associative cache is *slower but smarter* than a direct mapped cache, with 4-way and 8-way being slower and smarter again.

In most modern processors the instruction cache is usually highly set-associative, since its latency can be hidden by fetching and buffering. The data cache, on the other hand, is usually set-associative to some degree but often not overly so to keep down latency (2-way in Athlon, PowerPC G5, Athlon 64/Phenom, Cortex-A15; 4-way in Pentium-Pro/II/III, UltraSPARC-III/IV, Pentium-4, UltraSPARC-T1 & T2, Cortex-A8 & A9, Bulldozer; 8-way in PowerPC G4e, Pentium-M, Core 2, Core i, Core i\*2). As the last resort before heading off to far away main memory, the large on-chip L2/L3 cache is also usually highly set-associative, although external E-cache is sometimes direct mapped for flexibility of implementation.

The concept of caches also extends up into software systems. For example, main memory is used to cache the contents of the filesystem to speed up file I/O, and web caches (also known as proxy caches) cache the contents of remote web servers on a more local server. With respect to main memory and virtual memory (paging/swapping), it can be thought of as being a smart, fully associative cache, like the ideal cache mentioned initially (above). After all, the virtual memory system is managed by the (hopefully) intelligent software of the operating system kernel.

## **Memory Bandwidth vs Latency**

Since memory is transferred in blocks, and since cache misses are an urgent "show stopper" type of event with the potential to halt the processor in its tracks (or at least severely hamper its progress), the speed of those block transfers from memory is critical. The transfer rate of a memory system is called its *bandwidth*. But how is that different from *latency*?

A good analogy is a highway... Suppose you want to drive in to the city from 100 miles away. By doubling the number of lanes, the total number of cars that can travel per hour (the bandwidth) is doubled, but your own travel time (the latency) is not reduced. If all you want to do is increase cars-per-second, then adding more lanes (wider bus) is the answer, but if you want to reduce the time for a specific car to get from A to B then you need to do something else – usually either raise the speed limit (bus & DRAM speed), or reduce the distance, or perhaps build a regional mall so that people don't need to go to the city as often (a cache).

When it comes to memory systems, there are often subtle tradeoffs between latency and bandwidth. Lower latency designs will be better for pointer-chasing code, such as compilers and database systems, whereas bandwidth-oriented systems have the advantage for programs with simple linear access patterns, such as image processing and scientific code.

The two major memory technologies of recent times, standard SDRAM and Rambus RDRAM, differ slightly in this respect – for any given level of chip technology, SDRAM should have lower latency but RDRAM should have higher bandwidth. This is due to the "snake-like" physical structure of RDRAM memory systems, which reduce signal reflections by avoiding splitting the wires that normally go to each memory module in parallel, and instead go "through" each module in sequence – allowing RDRAM to run at higher clock speeds but with a longer average physical length to the memory modules.

Of course, it's reasonably *easy to increase bandwidth* – simply adding more memory banks and making the busses wider can easily double or quadruple bandwidth. In fact, many high-end systems do this to increase their performance, but it comes with downsides as well. In particular, wider busses mean a more expensive motherboard, restrictions on the way RAM can be added to a system (install in pairs or groups of 4) and a higher minimum RAM configuration.

Unfortunately, *latency is much harder* to improve than bandwidth – as the saying goes: "*you can't bribe god*". Even so, there have been some good improvements in *effective* memory latency in past years, chiefly in the form of synchronously-clocked DRAM (SDRAM) which uses the same clock as the memory bus. The main benefit of SDRAM is that it allows *pipelining of the memory system*, because the internal timing aspects and interleaved structure of SDRAM chip operation are exposed to the system and can thus be taken advantage of. This reduces effective latency because it allows a new memory access to be started before the current one has completed, thereby eliminating the small

amounts of waiting time found in older asynchronous DRAM systems, which had to wait for the current access to complete before starting the next (on average, an asynchronous memory system had to wait for the transfer of half a cache block from the previous access before starting a new request, which is often several bus cycles).

In addition to the reduction in effective latency, there is also a substantial increase in bandwidth, because in an SDRAM memory system multiple memory requests can be outstanding at any one time, all being processed in a highly efficient, fully pipelined fashion. Pipelining of the memory system has dramatic effects for memory bandwidth – an SDRAM memory system generally provides double or triple the sustained memory bandwidth of an asynchronous memory system, even though the latency of the SDRAM system is only slightly lower.

Will further improvements in DRAM technology be able to continue to hold off the memory wall, while at the same time scaling up to the ever higher bandwidth demanded by more and more processor cores? Or will we soon end up constantly bottlenecked by memory, both bandwidth and latency, with neither the processor microarchitecture nor the number of cores making much difference, and the memory system being all that matters? It will be interesting to watch...

## Acknowledgements

The overall style of this article, particularly with respect to the style of the processor "instruction flow" and microarchitecture diagrams, is derived from the combination of a well-known [1989 ASPLOS research paper](#) by Norman Jouppi and David Wall, the book [POWER & PowerPC](#) by Shlomo Weiss and James Smith, and the two very famous Hennessy/Patterson textbooks [Computer Architecture: A Quantitative Approach](#) and [Computer Organization and Design](#).

There have, of course, been many other presentations of this same material, and naturally they are all somewhat similar, however the above four are exceptionally good (in my opinion). To learn more about these topics, those books are an excellent place to start.

## More Information?

If you want more detail on the specifics of recent processor designs – and something more insightful than the raw technical manuals – here are a few good articles...

- [Intel's Sandy Bridge Microarchitecture](#) – the latest and greatest Intel x86 processor design, the Core i\*2, representing somewhat of a blending of the Pentium-Pro and Pentium-4 design styles.
- [AMD's Bulldozer Microarchitecture](#) – the novel "sharing" approach used in AMD's latest processor design, blurring the lines between SMT and multi-core.
- [Inside Nehalem: Intel's Future Processor and System](#) – the Core i microarchitecture, Intel's previous mainstream x86 processor design.
- [Intel's Next Generation Microarchitecture Unveiled](#) – Intel's reinvention of the venerable P6 core from the Pentium-Pro/II/III/M to produce the Core microarchitecture.
- [Niagara II: The Hydra Returns](#) – Sun's innovative UltraSPARC-T "Niagara" multi-core processor, revised for a second generation and taking thread-level parallelism to the extreme.
- [Inside the IBM PowerPC 970 \(and Part II\)](#) – the PowerPC G5, including comparisons to the PowerPC G4e and Pentium-4.
- [The Pentium 4 and the PowerPC G4e \(and Part II\)](#) – a comparison of the very different designs of two extremely popular and successful processors.
- [Into the K7 \(and Part II\)](#) – the AMD Athlon, the only competitor to ever really challenge Intel's dominance in the world of x86 processors.
- [The AMD Opteron Microprocessor \(video\)](#) – a 1 hour seminar covering both the Opteron/Athlon 64 processor and AMD's 64-bit extensions to the x86 architecture.
- [A Look at Centrino's Core: The Pentium M](#) – an examination of how Intel turned the Pentium-Pro/II/III into the low-power Pentium-M processor.
- [Crusoe Explored](#) – the Transmeta Crusoe processor and its software-based approach to x86 compatibility.

And here are some articles not specifically related to any particular processor, but still very interesting...

- [Designing an Alpha Microprocessor](#) – a fascinating look at what really goes on in the various stages of a project to make a new processor.
- [Things CPU Architects Need To Think About \(video\)](#) – an interesting 80 minute seminar given by Bob Colwell, one of the principle architects of the Pentium-Pro/II/III.

And if you want to keep up with the latest news in the world of microprocessors...

- [Ars Technica](#)
- [AnandTech](#)
- [Microprocessor Report](#)
- [Real World Tech](#)

That should keep you busy!

Liked the article? Why not check out this iPhone app of mine...

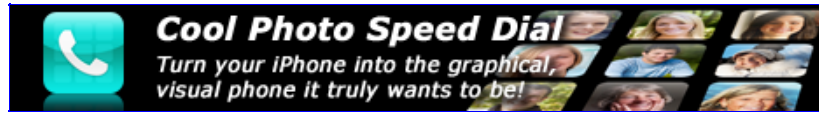

Lighterra > Articles & Papers > Modern Microprocessors - A 90 Minute Guide!

Copyright © 2001-2012 Lighterra. All rights reserved.  
[Contact](#) | [Privacy](#) | [Legal](#)