

Knottting

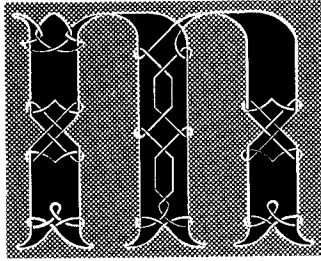

Matters

THE NEWSLETTER OF THE

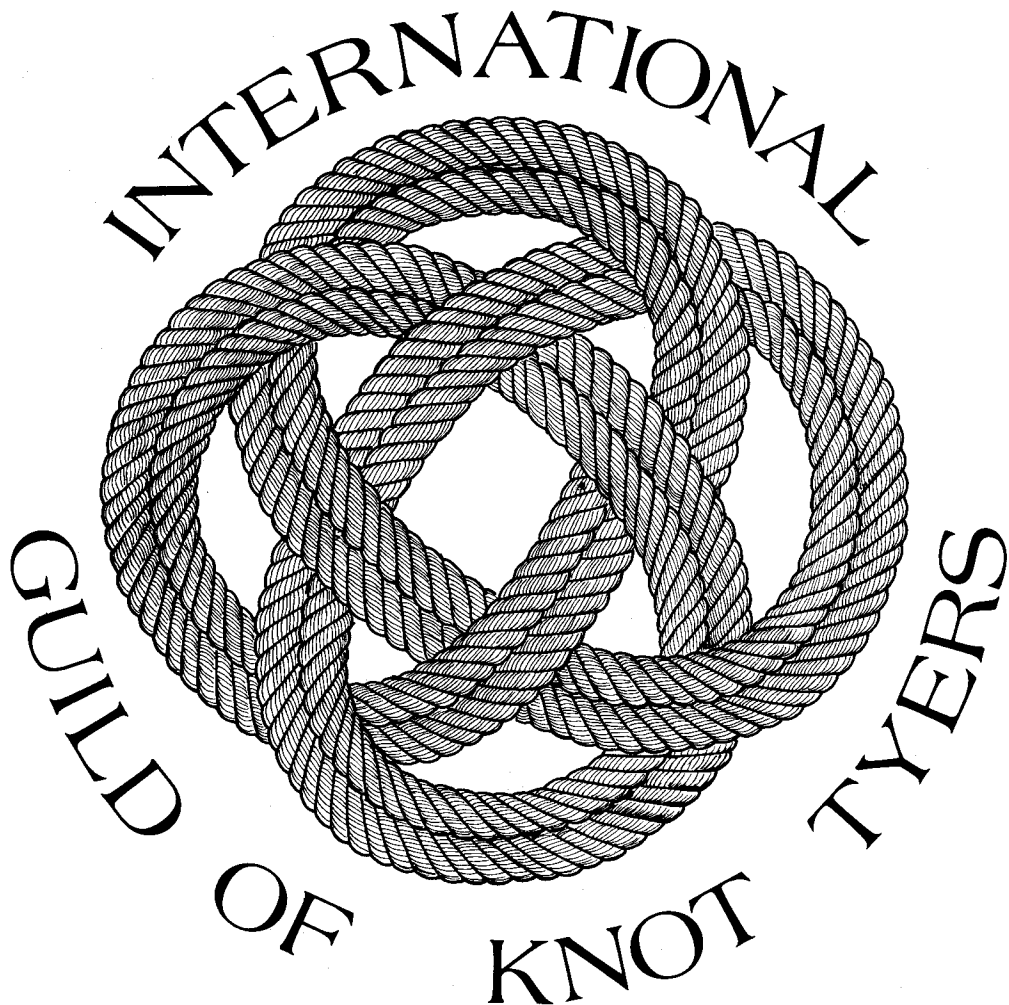

"KNOTTING MATTERS"

THE QUARTERLY NEWSLETTER OF THE
INTERNATIONAL GUILD OF KNOT TYERS

Hon. Sec. & Editor
Geoffrey BUDWORTH,

President: Eric Franklin

45, Stambourne Way,
Upper Norwood,
London SE19 2PY,
England.

Issue No. 16
July (Summer) 1986

01-653 8757 (home)
01-760 0759 (office)

--- oOo ---

Editorial

If you spend time alone in a school, college or office, out of hours you quickly realise it has ceased to be any sort of workplace. Without what goes on there between people it is only empty rooms, abandoned equipment.

So, too, our Guild is nothing - just an odd notion in the minds of individuals - except when we interact together at gatherings or through the link of this newsletter. Only then does it really live, grow, evolve. That's why the "Knotting Extravaganza" has proved such an inspiration.

This editorial is being cobbled together nearly two months before the great day but will not be read until a month or so after it is done and gone. No matter. What happens/happened then is important, of course, but of far greater value - it can be said even now - is what has already occurred preparing and planning for it.

Working at our knotting assignments many of us have picked up new skills, more know-how; and in some instances increased confidence and a quiet authority have resulted from mastering some knotwork previously thought beyond our humble fumblings. Such gains last. Minds stretched by new ideas never go back to their old dimensions.

The letters, phone calls and actual get-togethers generated by the giant project have all brought us closer, while the search for sponsors and publicity has reinforced and spread our reputation afield.

The Guild begins its fifth year of life thriving and active, our roles within it enriched, because we chose to pursue for fun the whimsical idea of our "Extravaganza". Clifford Warren Ashley would have liked that.

"Hang Judas"

Land lubbers cannot always see the point of sea-going jargon but it can combine terse technicalities with marvellous imagery. A rope, cord or thread "hangs Judas" in sailors' language when it is left suspended, swinging and dangling, loose and free.

A Page of Knots

by Eric Franklin

I. LEARN A NEW KNOT

One of the knots required for the First Class Badge was the Man Harness Knot. While this serves its purpose well and is something of a "traditional" knot, you always lose some of the loop in drawing up and it may not be perfectly secure in certain circumstances. There are better knots which will serve the same purposes: the Farmer's Loop is one of them and it is more fun to tie.

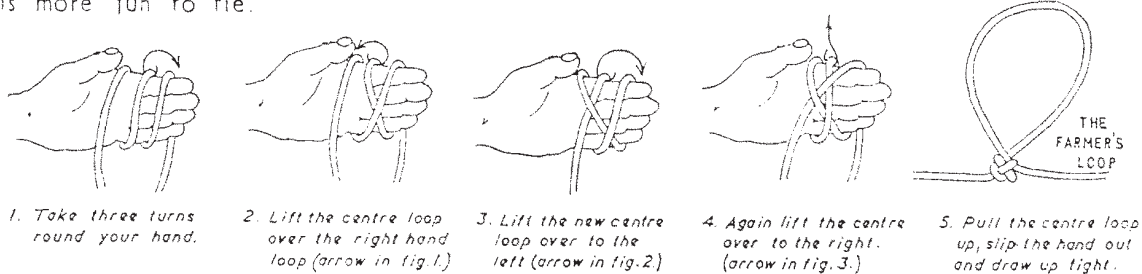

While learning the knot, find out by trial how deep you must make loops round the hand to get the final loop the right size.

2. STRAPS, STROPS OR SLINGS.

A strap, sometimes called a strop, is an endless loop of rope or other cordage and a sling is a larger version of the same thing. It is usually made by taking a suitable length of rope and splicing the ends together but a temporary or emergency strap or sling is equally satisfactory with knotted ends. Basically a strap is the "wreath" round a block but we can find other uses for it.

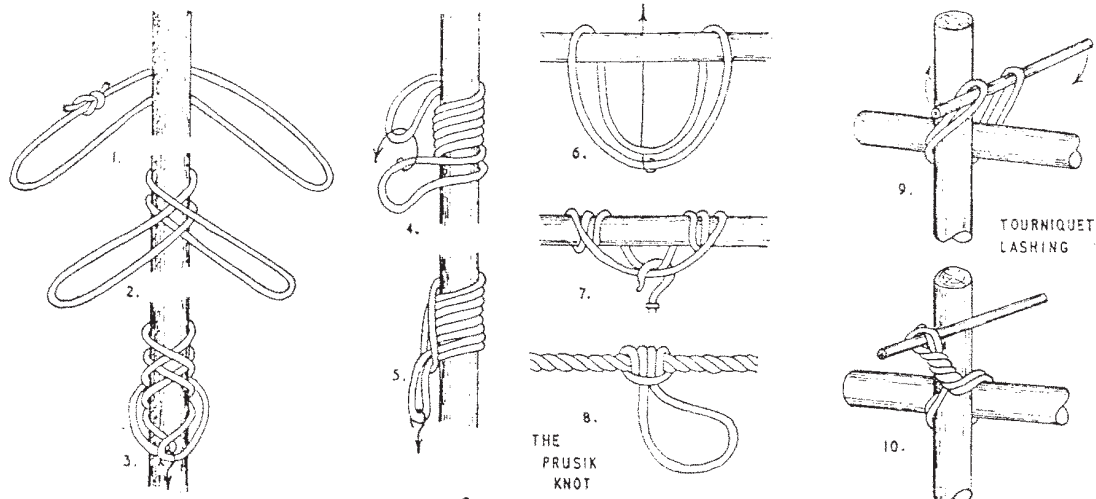

1,2,3. This is the seaman's way of securing a block to a spar but it will serve you equally well on your tent pole to hold a clothes hanger for your best things — or a lantern at night. 4 and 5 show an alternative way of using a strop for these purposes. 6 and 7 show how a strop is similarly used on a horizontal spar — or tent pole. The Prusik Knot is an adaptation of the last one, and is used by climbers to attach a karabiner to the climbing rope. 9 and 10 show a novel way of making a lashing: it is called a Tourniquet Lashing and it was devised by Gilwell. To find out more about it (and also several other novel lashings) you must read "Pioneering Principles" by John Thurman. Incidentally, when you have got as far as fig.10, you must lash the tourniquet bar to one of the spars. I am sorry there is no room left to tell you about slings as well.

Quotation

"....it would be interesting to meet such a passionate admirer of fine ropework that he would steal from a Cathedral."

Capt. Paul P.O. Harrison - At Sea - 1963 (recording the Canon's response to the theft of a Harrison bellrope from Rochester Cathedral).

Long Turk's Heads

Simple Ways to Make Them ◊
and Remember How!

by *Capt. C. Allan McDowall* Master Mariner

No.3 - Inter-twined, "origami" method

In my last article I showed you how tough paper can be used to plan a knot, then to hold the 'pilot' twine in place while the knot is formed, and finally removed in pieces when the knot is complete. Let's now explore the possibilities of this method further.

You can make two - or more - Turk's Heads intertwined with each other. Two Turk's Heads made like this as one knot produce features that the knot made with a single strand does not have. Two contrasting cords can be used. Knots of EVEN numbers of parts can be made where the loops lie opposite each other (instead of being staggered) and where each end is of the same handedness.

The double 3-bight, 4-part long Turk's Head (Fig. 1) (effectively a 6-bight, 8-part knot) makes a very handsome tiller grip for a yacht, fit to jerk admiration from the most staid member of the "utility only" school. To make such a knot freehand is, I think, really difficult. Making it by the "origami" method is EASY.

The finished knot looks something like this...only better, tied in contrasting cords.

Fig. 1

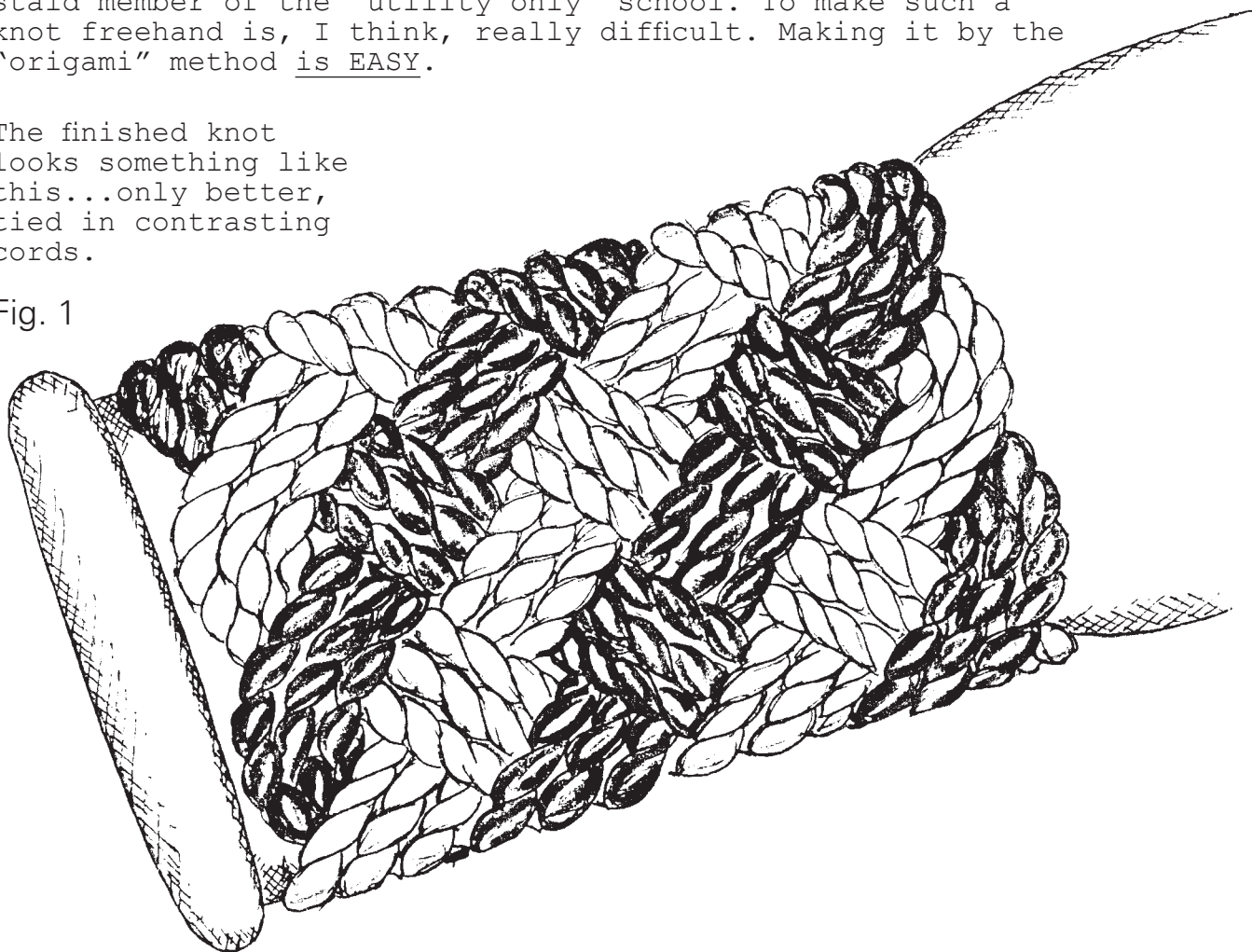

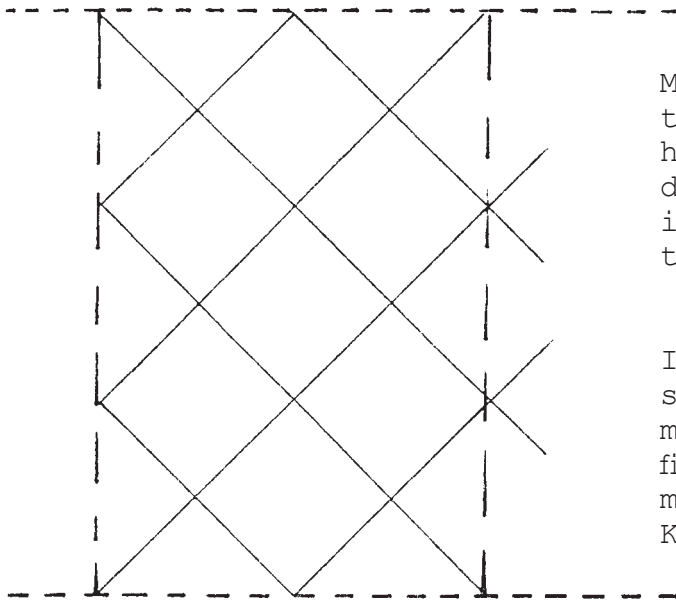

Fig. 2

Making the knot with contrasting cords gives a helical effect which is distinctive and shows each individual knot as an integral part of the whole.

If the following step-by-step account of how to make the pattern is not at first obvious, look back at my last article (No. 2 in K.M. issue No. 15).

1. Mark the circumference with 1/4"-1/2" paper slack;
2. Draw the lefthand margin;
3. Divide the LH margin into the number of bights (in this case - 3);
4. From these marks, draw lines at 45 degrees;
5. Count the number of parts from the LH margin (in this case - 4), and draw the righthand margin;
6. Erase lines to the right of the RH margin;

You have drawn (Fig. 2) one 3-loop, 4-part Turk's Head.

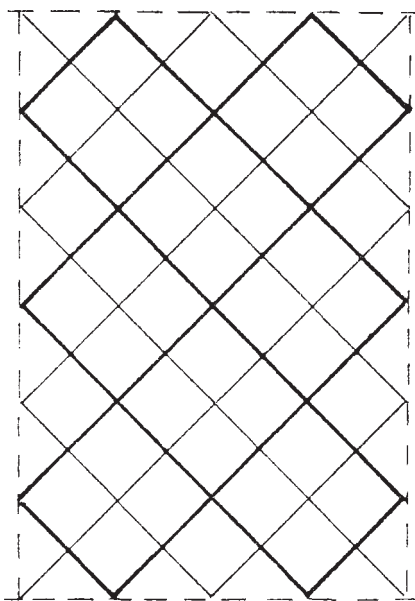
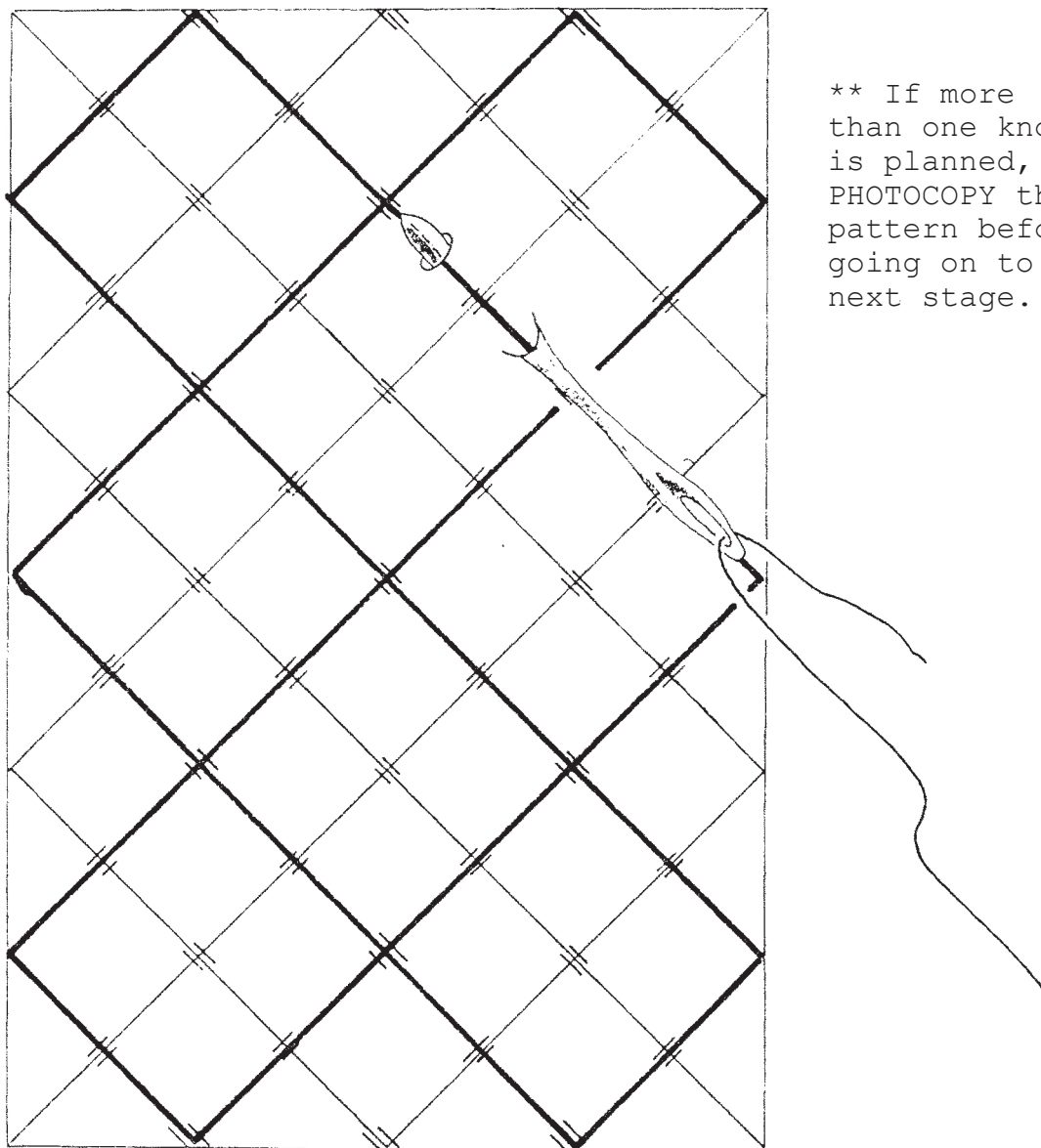

Fig. 3

7. Now draw another one, the same, but displaced (thick line, Fig. 3) by half the interval between loops;
8. Mark in the 'bridges' (Fig. 4)** and don't - I advise - try to skip this step;
9. Wrap your paper pattern around the object to be covered and glue it in place;
10. With a blunted sail needle and soaped twine, stitch round



** If more than one knot is planned, PHOTOCOPY this pattern before going on to the next stage.

Fig. 4

pattern UNDER the 'bridges' (Fig. 4). Use contrasting twine for each knot,

11. Tie contrasting cordage to each length of twine and pull cordage right through each knot layout, displacing the twine as it proceeds;
12. Follow round each knot again (doubling or trebling as required. Remove the paper remnants. Tighten up the knot(s), concealing all cord ends.

THE NEXT ARTICLE, number 4 in this series, tells how to tie 'T'-shaped and 'X'-shaped Turk's Heads.

LIFT KNOT

...from the instruction manual of Kone Marryat Scott Ltd. (Lift Repair Specialists), Birmingham, England;

kindly supplied by their Repairs Supervisor, Mr. C. Harber.

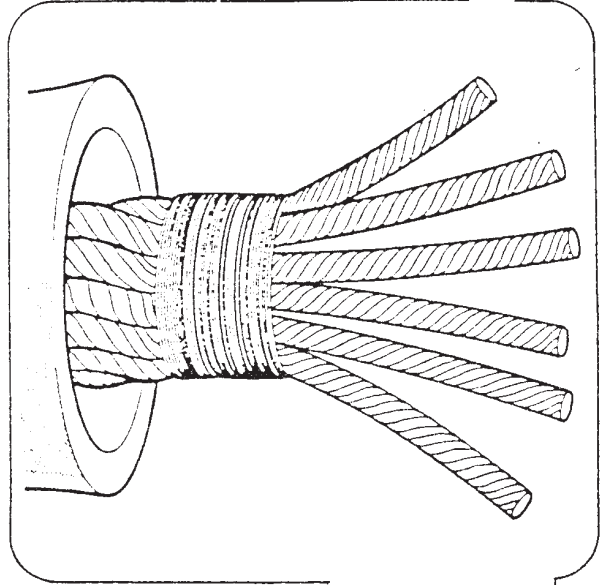

Dry rope socket

Making a dry rope socket:

1. Pass the rope end through the socket and open out the strands above the socket.
2. Straighten each strand.

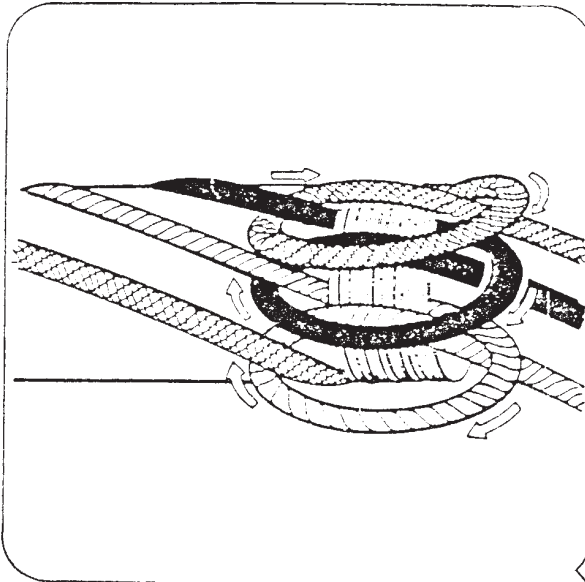

5. Pass each strand under the next strand continuing in the same direction round the rope.
- The strands will now point back along the rope away from the knot. Pull each strand tight to tighten the whole knot.

Special terminal KNOT/SPLICE for lift hawsers

3. Take each strand over and under in a clockwise direction to the strand next to it.
4. Pass the strand through the centre of the rope and pull it out in the original direction.

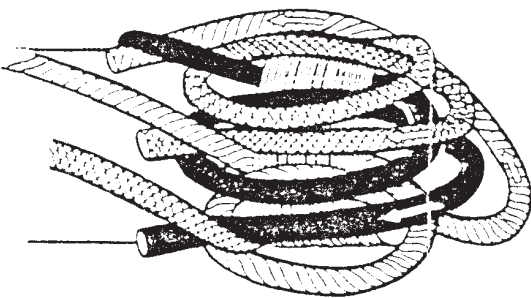

Adjustable Bend *by Rob CHISNALL*

The 'Adjustable Knot' (Fig. 1) which I devised in 1982 was first published in 'The Knot Book' (1983) by Geoffrey Budworth, and we were both surprised recently when we realised it had not appeared in any one of the Guild's newsletters.

This practical slide-&-grip knot can be shifted easily in either direction but locks up firmly under load. After release, it may once again be slid along the rope.

Two of the knots make an Adjustable Bend (Fig. 2) and, joining both ends of a single piece of rope or tape, create an adjustable strop or sling (Fig. 3). Guidance on its use in extreme situations appears in 'The Rock Climbing; Safety Manual published by the Ontario Rock Climbing Association (Association Ontarienne de Varappe) (1984).

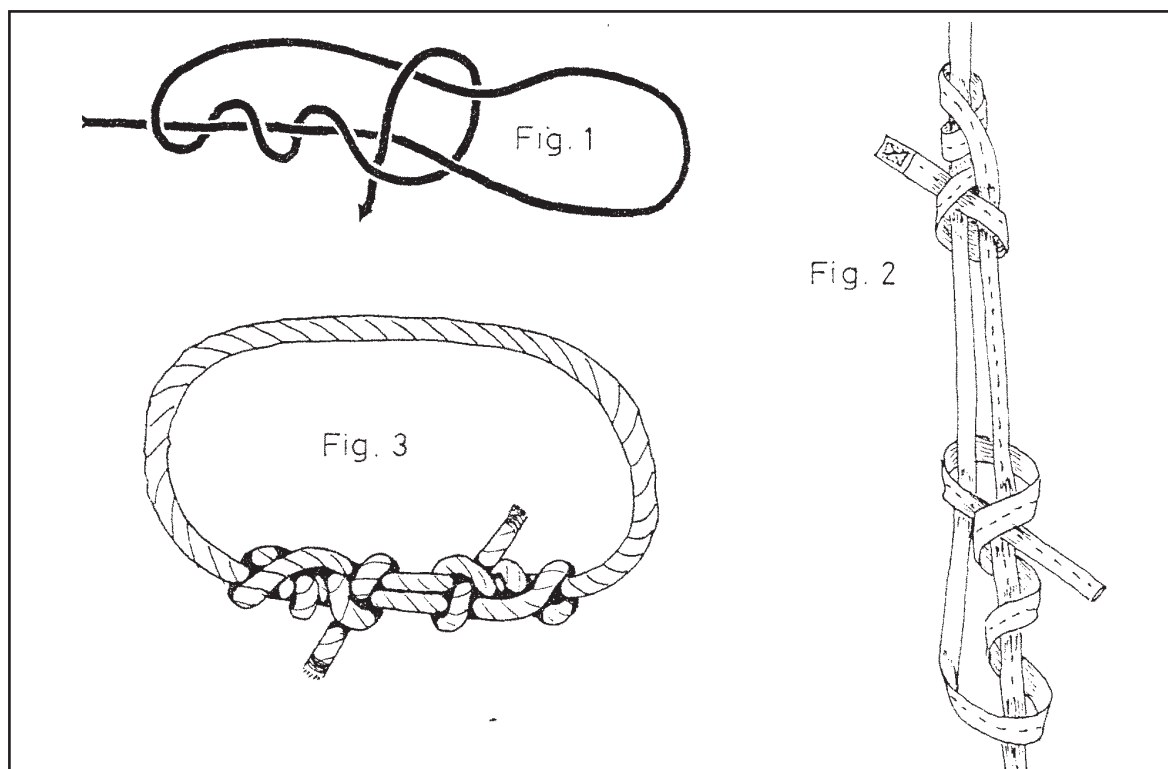

The adjustable bend is described in the O.R.C.A. Safety Manual as having a slipping or failing load of no more than 550 pounds (248kp.). This was a rather conservative quote based on tests involving inconstantly applied loads. Recent tests involving 5.5mm. kevlar indicate that the adjustable bend grips - does not slip - and breaks at around 80% of the absolute rupture load of the material used.

Since those initial tests were performed on the O.R.C.A.'s dynamic belay guage (primarily designed for drop tests) and the latter test was conducted on a more accurate Dillon dynamometer, we plan to conduct further tests to determine whether or not this experimental disparity is a consequence of the different guages or of the unique

properties of kevlar. We suspect that the adjustable bend is far stronger than previously reported.

Obituary

JOHN CLARK of Nuneaton, Warwickshire, England, was killed in a car crash late last year. He joined our Guild in October, 1983, and the time we had to know him was cut tragically short. John helped out at our first display for the Birmingham Boat Show and was last seen with his handiwork at the Bristol gathering. He is remembered as "a lovely gentleman"

Then & Now *by Brian LAMB*

That old Scout funster Jack blunt was a good source of not lore years ago. His advice on securing clove hitches (reproduced below) appeared in his book 'More Stunts and Ideas' (1939).

About the Clove Hitch.

A CLOVE hitch is a clove hitch all the world over, whichever way you look at it, whether you tie it round your arm, or round the leg of a clubroom chair. Unless it has a continual strain en either site it should be finished off with a half-hitch. This is a common thumb knot made by simply tying the two ends together. See sketch.

If you want to make the clove hitch doubly strong make a second turn before you finish it off. Again see sketch.

If you want to make a temporary clove hitch which will hold fast but can be released quickly, turn one of the ends back on itself as you see in the fourth sketch.

Useful to know all those things. Try them out. Don't forget that in camp all ropes attached to stakes, such as in the kitchens, or for towel rails and things, should be fixed with clove hitches.

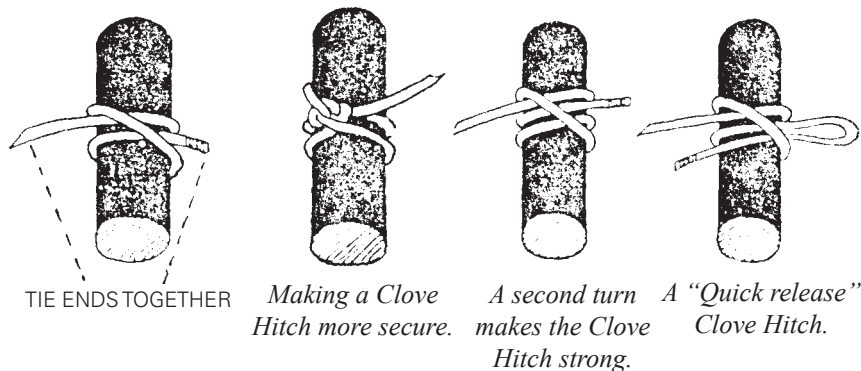

Lashings, about which I have already held forth, are always begun and finished off with clove hitches.

Our 'KM' editor - G.B. - tells me that the "quick-release" clove hitch was insisted upon to suspend car tyre fenders from the handrails running fore-to-aft atop the cabins of river police duty boats when he patrolled afloat on the Thames tideway in the 1960s.

Jack Blunt's book also features the "slip-shank" for a variation of the sheepshank which has not survived to be seen in today's knot manuals, unless knotted at both ends.

Sheepshank-New Style.

I'VE just come across a new angle on our old friend the sheepshank, the knot we use for shortening a rope, or taking up the slack in a line. It is a neat affair, and to my mind seems more efficient for its



job than the sheepshank. The diagrams show fairly clearly how the knot is made in the rope, and it almost defies understandable description. Anyhow, for people who like technical details, here is the official description (and the picture):

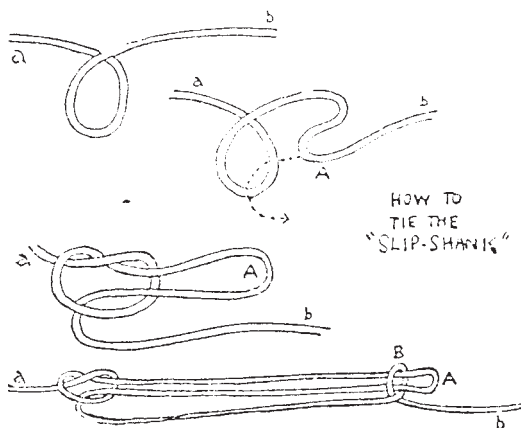

Grasp end a with the left, hand and take the bight A with the right hand. Tie a simple overhand knot.

Adjust the slip knot you have thus made to the required length and take a half hitch over the bight A with end b. Serves you right!

People who are interested in knots - and I know there are hundreds of you - will like to

make and use the "Slipshank," as it has been termed. But remember it doesn't take the place of the sheepshank, and don't push it under the nose of your Patrol Leader when he tells you to tie a sheepshank!

The simply way to impart tying a common bowline (some rabbit emerging from his hole, scampering around a tree, and disappearing once more down the burrow) is belittled by many who claim that the sailor's one-handed technique must

always be preferable. Such purists won't like J.B.'s other gem from the past, tying a bowline from the lyrics of a popular song. Still, it's all history now.

The Music Goes Round.

AT last, for the very first time in my somewhat ridiculous career, I have come across a brand new idea. It must be new. It is not a variation of anything, else, it is not sonic old idea dressed up in new clothes. In fact, it is an invention. *And to the 7th Brockley (St*

David's) Group, must go the credit for its origin. And do I love it?

It happened this way . . . The A.S.M. was showing a new fellow how to tie the bowline. He had come up for passing the Tenderfoot test, but had stumbled over this particular knot. And could that fellow learn the bowline? No!

The A.S.M. tried all ways. "Rabbit out of the hole," 'n everything.

When things were at their very worst the A.S.M. had a brainwave, and it was at that moment that the new idea was born.

"It goes up here, the music goes round and around

Whoo-oo-oo-oo-oo-oo. . . And it goes down here." The pictures will show you the whole idea. It's perfectly priceless.

For the people who want the modern touch, here you are!

Up-to-date now, I came across the snippet (below) for a film 'The Art of Knotting' while thumbing through an educational slide catalogue from Focal Point Audiovisual Ltd., 251, Copnor Road, Portsmouth PO3 50E (tel: 0705 665249). The price was according to their March, 1985, pricelist.

The Art of Knotting -

One double frame colour filmstrip

The emphasis of this filmstrip is on knotting techniques illustrated by original work. The photographs show the possibilities of this age old craft as a modern art form and also its application to its use in everyday things.

Price: inclusive of teaching notes: **£6.50p. CODE G**

Any I.G.K.T. member wishing to buy a copy of this film should contact Focal Point Audiovisual Ltd. direct...not us.

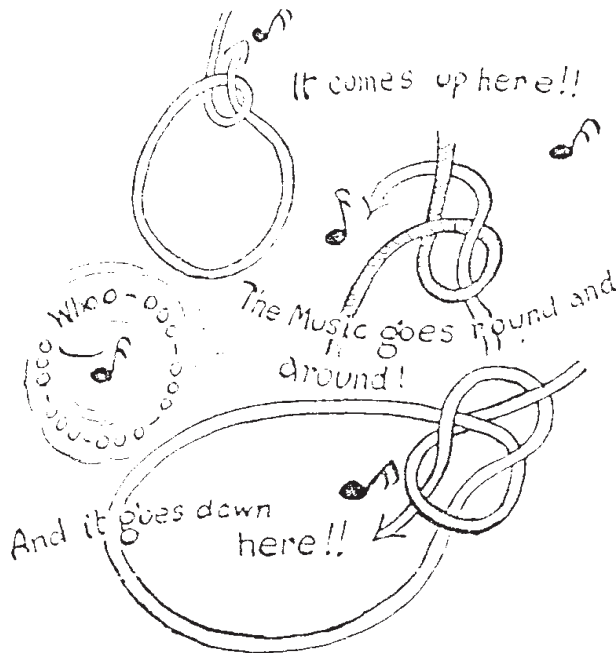

A Clever Twist the 'Richardson knot'

Invented - so Fire Service lore has it - by Station Officer Richardson, Middlesex Fire Brigade, England, to rescue a pregnant woman from a building.

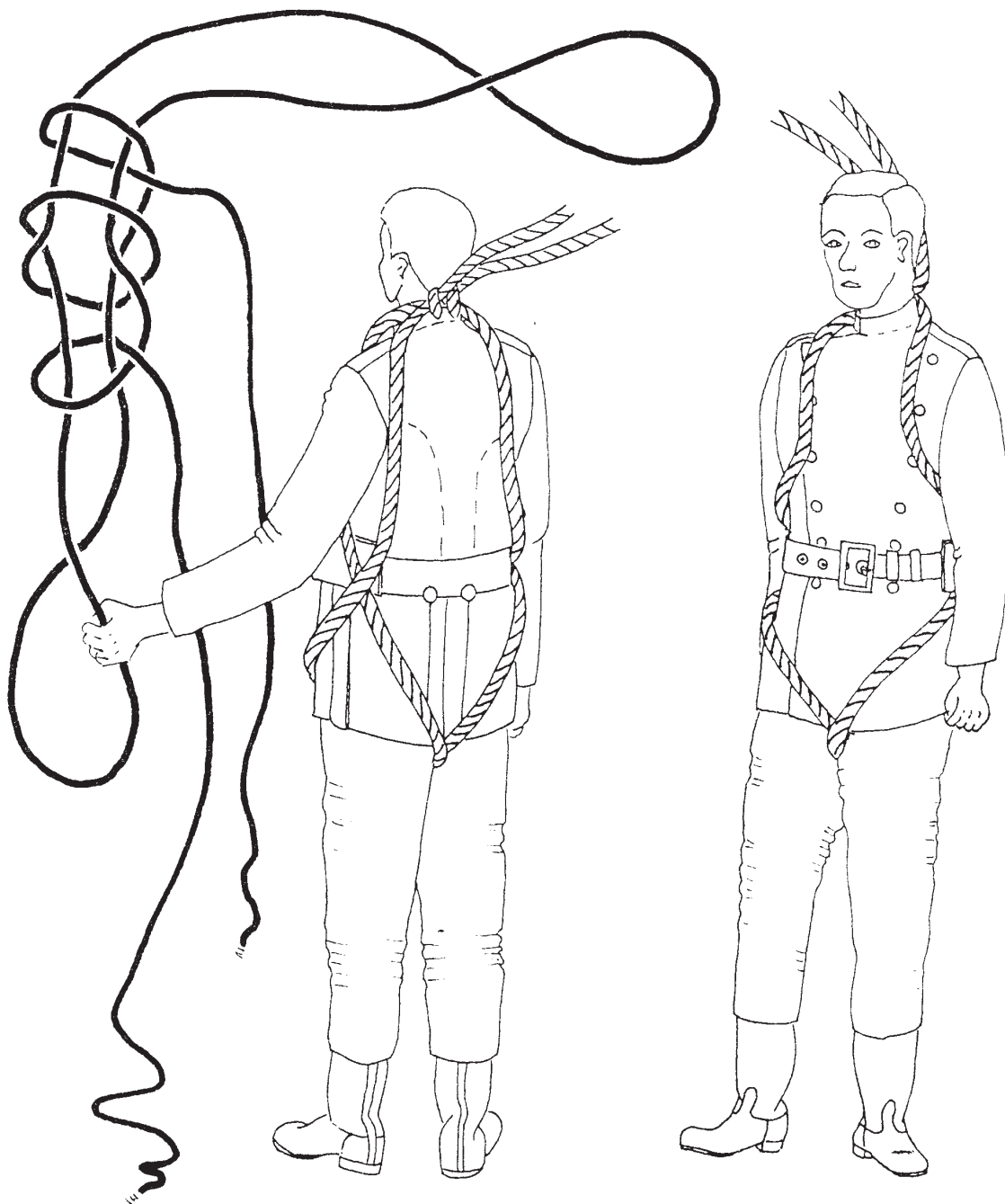

A standard fire services chair knot (note: they seem to see no harm in the Tom Fool's layout) is made with each long loop the same length and twisted. This arrangement upon an individual is then similar to a parachute harness and avoids pressure on the abdomen which might otherwise be harmful in cases of pregnancy, stomach wounds, etc.

Cartoon

Non-Scouts may need explained that the cellist on our left has contrived a pioneer's suspension bridge.

From 'SCOUTER'
(June, 1950)

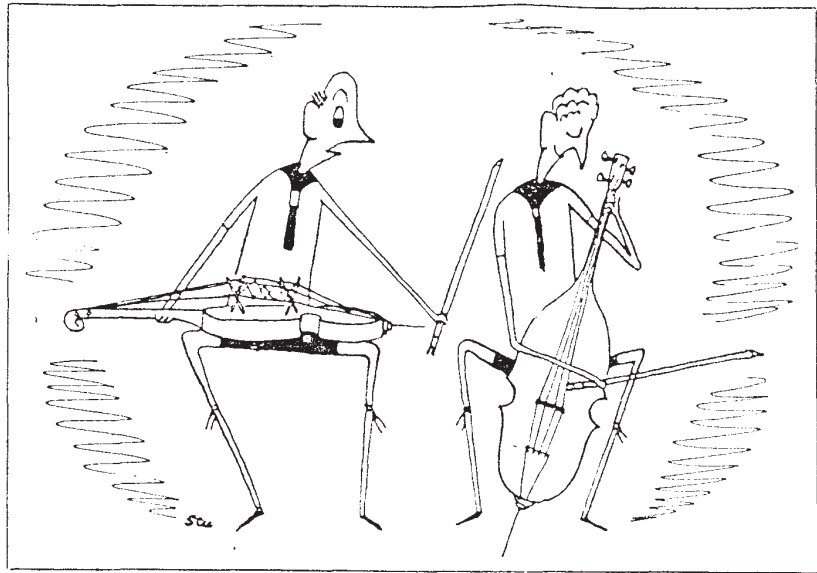

"Psst! Harold!"

Letters

Dear Geoffrey,

Looking once more at the twenty-four beautifully drawn knots in 'K.M.' No. 2 ('The Russian Connection', pages 10-11), I was surprised to find that knot No. 5, a Marlinspike Hitch, is drawn wrong. The bight which has been slipped through the loop is taken from the running end, and in use will immediately pull out; it should, of course, be taken from the standing end. I can't believe that Russians tie it the way it is drawn. The fault must lie with the artist.

They are funny about marlinspikes. In my dictionary I find; "Vymenyat shpilo na svaiku." Translated literally this is; "Two swap an awl for a marlinspike". The dictionary gives it as; "To strike a bad bargain." They don't seem to rate marlinspikes highly!

All best wishes and kind thoughts
to you and Knotting Matters,

Harry ASHER

Birmingham,
England

23-1-86

Dear Geoffrey,

I have been re-reading the back numbers of Knotting Matters. What a vast amount of material is available for discussion and analysis by both experts and layfolk. Dr. Asher is quite right in his condemnation of Ashley and I fully support him in his appraisal (K.M. No. 11, pages 16-17) of the qualities of the single Carrick Bend.

On the occasion during my sea career I had to use the Carrick Bend, I always half-hitched the ends back onto the standing part and then put a seizing on. Invariably I used a double Carrick Bend as illustrated in 'Nicholl's Seamanship

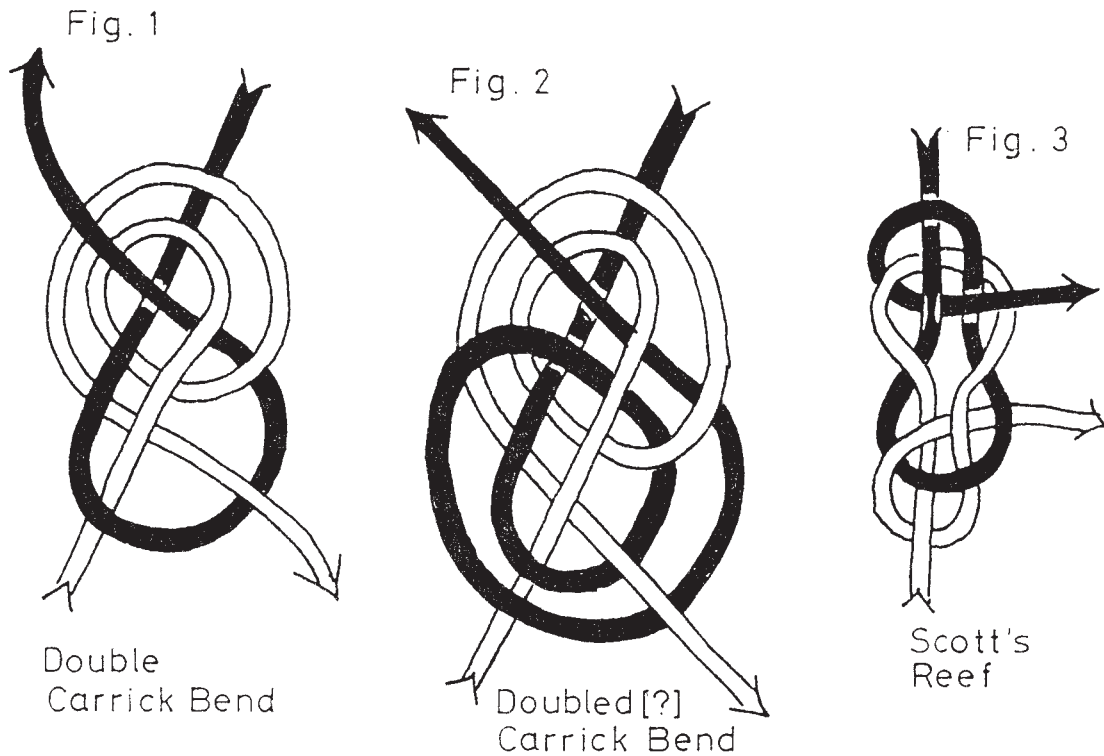

& Nautical Knowledge', 21st. edition (1959). My books are limited but I have been unable to find this bend in Ashley, Spencer, Irving, or the 'Admiralty Seamanship Manual', volume II (1964). The Admiralty manual calls Ashley's full Carrick Bend a "double" Carrick Bend...more confusion.

I feel there is a great amount of work to be done on Ashley. Why he refers to bend 1407 as a "Whatnot" I don't know; it's a Carrick Bend, drawn slightly different from 1445.

Back to the double Carrick (Fig. 1)...it really amounts to a full round turn over the cross of the first loop. I fiddled about (as I'm always doing) and carried this a step further by forming the first loop with a full round turn too. Drawn up the bend is secure, quite attractive, if a little bulky (Fig. 2).

As for the Reef Knot-as a joining bend - more confusion. The Admiralty Manual says; "...is used as a common tie for bending together two ropes of approximately equal size." Ashley says on page 73 that the steeplejack sometimes uses the Reef Knot for joining the two ends round the steeple... a long drop: Once again, I fiddled around and found that by dipping the ends round and through the centre from opposite sides (Fig. 3) I came up with a very secure bend, again a trifle bulky but not difficult to undo.

Finally, re. the Cod End Knot, when I was trawling pre-war it was the mate's job and responsibility to tie this knot. Otherwise, responsibility passed to the bo's'n, or else the skipper himself tied it. I well remember - as a very young bo's'n - tying my first Cod End Knot: I went through agony the whole of that 3+ hours tow, praying that we had a bag of fish when we hauled in. We did.

Issue No. 9, page 3 of 'K.M.' ('Knot Test - the Rolling Hitch') contains a transposition error. The diagrams are correct but the book references near the bottom of the page are not. The correct form is:-

"Straight" (Fig. (a)) = form of rolling hitch illustrated on p. 105 - fig. 110B - "The Art of Knotting and Splicing" (C.L. Day).

"jammed" is O.K.

"Reverse" (Fig. (c)) = form of roiling hitch illustrated on p.65 "Century Guide of Knots".

Sorry I've taken so long to send these corrections.

If it comes to a vote, you can put me down as strongly opposed to the whole idea of the I.G.K.T. wasting its time and resources establishing grading tests for knots people. If the I.G.K.T. does establish such tests, may I suggest that there be only one grade, that of "expert", and that title should be applied only to those persons capable of tying every knot appearing in Ashely, Graumont & Hensel, and Knotting Matters combined!

Cheerio for now,

Yours sincerely,

Peter ROSS

Auckland

New Zealand.

18 Apr 86

Quotations

"...the hunting of horses by means of that terrible weapon, of Central America, the lasso Let us see how the vaquero goes to work. Armed with his lasso - which is composed of three strips of raw leather, plaited, and is about forty feet in length. - and mounted on a powerful horse, he follows the animal he has selected until he finds himself within a proper distance for throwing his weapon with the best effect. Seizing the iron ring which is attached to one end or the lasso with his left hand, he draws the lasso through it with his right, and, stretching out his arms so as to make a noose of some six feet in length, he grasps the ring with his right hand, whirls the noose several times round his head, and hurls it with unerring aim, seldom failing in placing it around the horse's neck. The noose immediately runs up tight, when a dexterous twist causes a coil of the lasso to encircle its nose, and the interruption of respiration which ensues brings the horse to a dead halt."

'BOYS' OWN PAPER', Saturday, August 26, 1882.

"Now, with odd scraps of wood and string, Rolf ingeniously rigged up a food locker and a couple of shelves to keep our everyday supplies of tea, coffee, and sugar out of harm's way. He had to use string in place of nails or screws because Brendan's hull flexed so much that any rigid fastening would have snapped immediately."

'THE BRENDAN VOYAGE' by Tim Severin, pub. Hutchinson & Co. Ltd. (1978)

Meter Gauge

by Cy Canute

There used to be for rope-workers a nice wooden slide-rule made by 'Rabone' with brass calliper jaws for gauging the diameter of fibre cordage, so you could then read off the commensurate circumference (in inches, then, of course) on an adjacent scale. Useful tables of breaking strengths were also appended.

These devices now have extraordinary price tags (£60 the last time I looked) attached to them by antique dealers.

A modern version came my way recently (diagram alongside). It's plastic - what else? - and the jaws are adjusted by a small thumb-wheel operating a rack-&-pinion mechanism. The linear scale is millimetres and a dial is geared to display 10ths.(0.1) mm and even 100ths.(0.01)mm. The model in the diagram is set at 17.75mm. Work it out for yourself.

A secondary pair of jaws on the back of the tool will measure internal diameters; while, as the jaws open, a depth probe protrudes an identical length from the handle's end.

Clever, isn't it? Mind you, it doesn't do circumferences but see my piece in 'Knotting Matters' issue No. 7, page 4, for how to cope with that little sum.

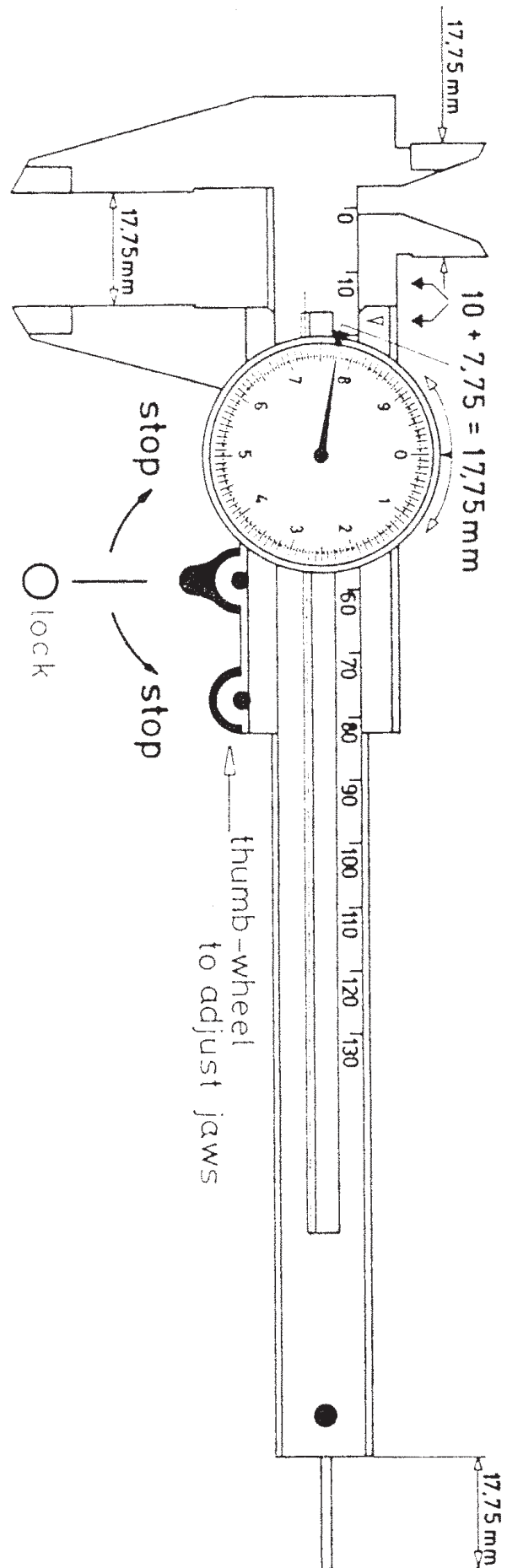

Quiz

It the Surrey Branch's pre-Christmas social evening we enjoyed John Smith's knot quiz: so here's another for all to share, devised much earlier by Guild President Eric Franklin.

The answer to each cryptic clue is a familiar knot, bend or hitch:-

- | | |
|-----------------------|--------------------------|
| 1. Fritillary knot | 10. Arboreal knot |
| 2. Feline knot | 11. Bedtime knot |
| 3. Royal knot | 12. Bricks & mortar knot |
| 4. Senile knot | 13. Dick Turpin's knot |
| 5. Distributor's knot | 14. Boxer's knot |
| 6. Desert island knot | 15. Reaper's knot |
| 7. Tumbler's knot | 16. Gorilla's knot |
| 8. Ovine knot | 17. Ottoman's knot |
| 9. Hidalgo's knot | 18. Medicinal knot |

(Answers will appear in the next newsletter)

From Farmer to Fisherman

by Harry Asher & Desmond Mandeville

Introduction

We two knotters had been working separately, HA on the Honda and related loops, and DM on variations of the Fisherman's Knot. In our correspondance it became apparent that our problems were related, and when we put our ideas together the project moved forward to give the results reported below.

Loops Based on the Overhand Knot

It will be convenient to refer to the three spaces in an overhand knot as the 's' (standing), 'c' (central), and 'r' (running) spaces (Fig. 1). Fig. 2 shows the Department Store Loop. For present purposes think of this loop as being made by tying the overhand knot so that the running end bearing the stopper knot passes through the overhand knot at 'a' and then retraces its path so that at 'b' it re-enters through the face which was the exit at 'a'; it goes back the way it went in, but in the opposite direction.

The question which started this enquiry was; 'Why are there no known loops made by bringing the running end back, not through the 'c' space but through one or other of the remaining two spaces 's' and 'r' (Fig's 3 & 4)? A simple trial gave the answer immediately. The two knots obtained in this way are not stable but immediately revert to the Department Store Loop of Fig. 2. They do so without any true change of tuck being made; i.e. you do not have to pull the end out through the overhand knot and put it in again anywhere else; the running part simply slips sideways into the central space.

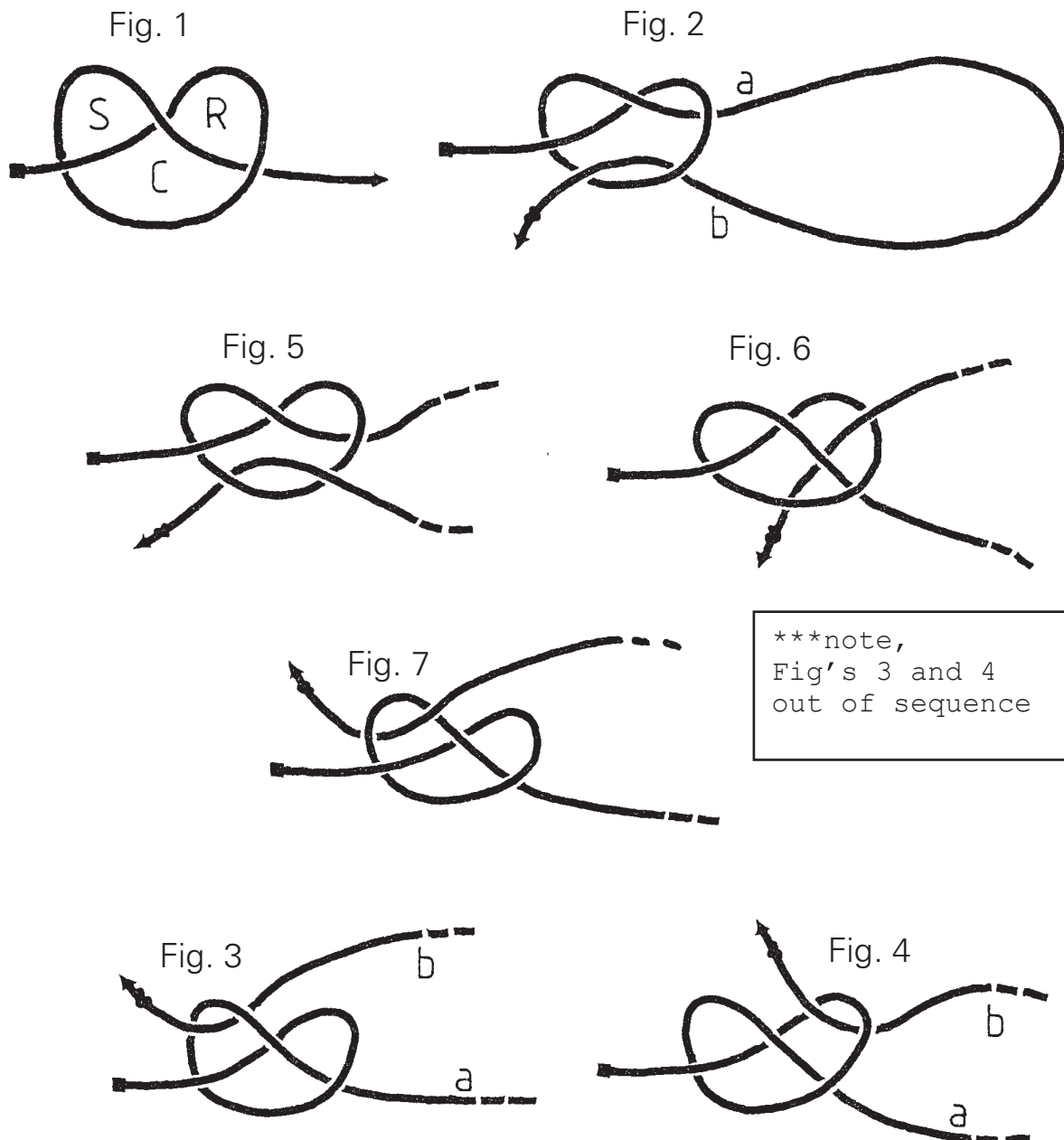

The next step was to find what would happen if the running end was brought through the knot at 'a' and 'b' not in opposite directions but twice in the same direction. The answers are as follows:

- (i) taking the end through the 'c' space gives the Farmer's Halter Loop (Fig. 5),
- (ii) taking the end through the 'r' space gives the Honda Loop (Fig. 6),
- (iii) taking the end through the 's' space yields what appears to be a new knot (however, excitement at the discovery is not overpowering because it seems to offer no advantage over (i) or (ii)!).

Fig. 8

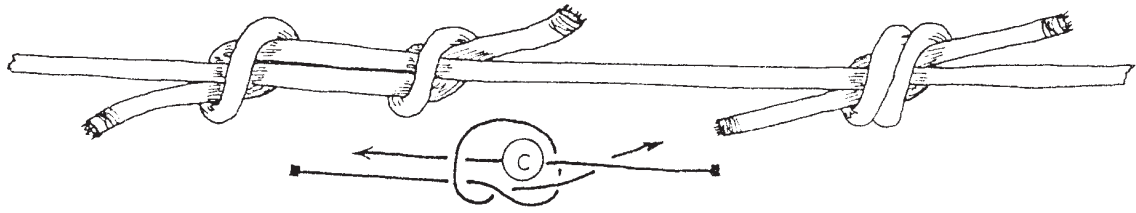

Fig. 9

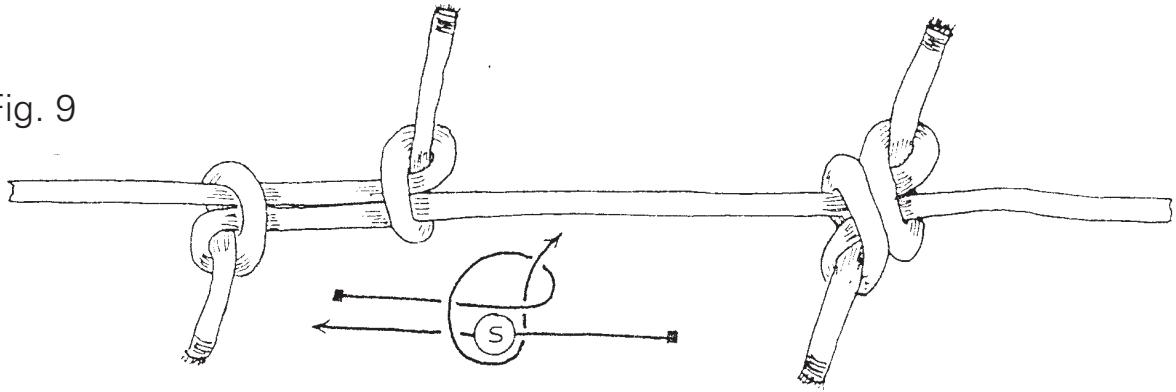

Fig. 10

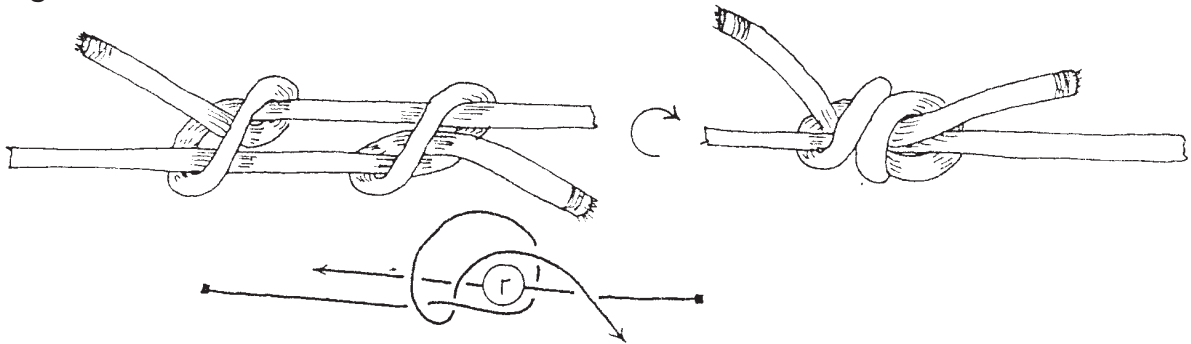
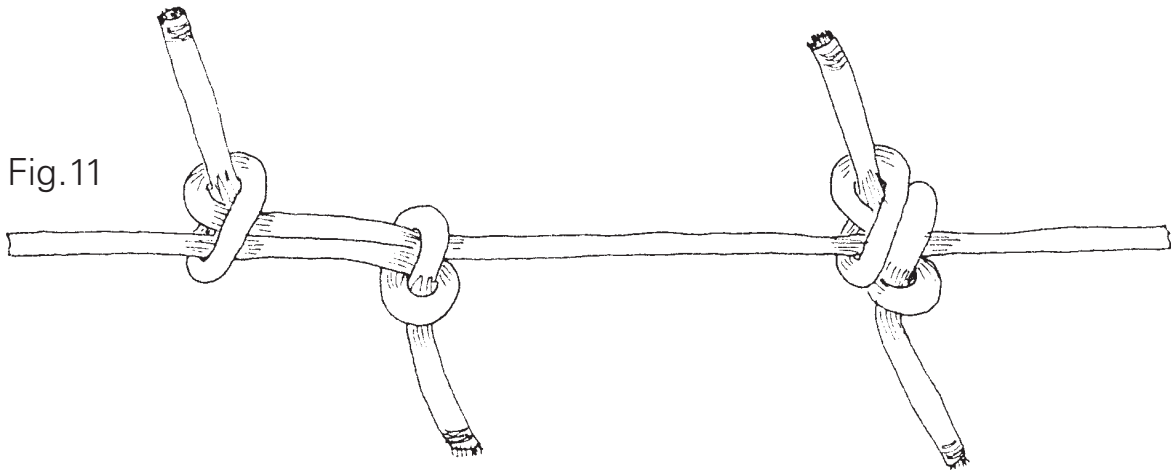

Fig. 11



Bends Based on Adjacent Overhand Knots

Similar distinctions may be made in the case of the Fisherman's Knot (actually a bend) in which two adjacent overhand knots are made to butt together, each being so tied as to encompass the lead of the other. In the ordinary Fisherman's Knot the overhands are always of a like handedness (and here shown righthanded). Furthermore, each lead can be seen to pass through the 'c' space of the opposing overhand (Fig. 8).

What is interesting is that equally stable arrangements follow when they are laid through the 's' or the 'r' spaces (Fig's 9 and 10). As long as the strands remain loosely tied, the 'c', 's' and 'r' forms may be manipulated to convert one into the other, without necessarily involving a change of tuck. Each will, however, draw up on its own characteristically and shows no tendency to slip into another form. When pulled up tight, the free ends in the ordinary form lie alongside the standing parts; in the second, almost at right-angles to them; and in the third, angled like the wings of a gull in flight. There can be few bends that exist like this in three distinct and equally stable forms!

A threefold choice similarly presents itself when UNLIKE-handed overhand knots are combined this way. Once again, the leads may thread their way through the 'c' 's' or 'r' spaces of the opposing overhand. Only in the 's' case, though, do the two knots fit really snugly together (Fig. 11). The resulting bend is notable for two reasons:

- (a) unlike the better known Fisherman's Knot, both faces (front and back) are alike making it an elegant and symmetrical bend,
- (b) once it has been pulled tight it is rarely possible to separate the overhands by pulling on the free ends (easy enough with the ordinary Fisherman's Knot). The two overhands are in effect locked together. The more you pull, the tighter the grip. Almost, it could be said to function as a bend with the free ends treated as standing parts.

Footnote

What happens when (Fig's 2 to 7) the free end is pulled out of the knot so as to "collapse the loop? In Fig's 2, 3 and 4 the entire knot vanishes. The Farmer's Halter Loop reduces to the Double Overhand Knot, Ashley 516; the Honda or Bowstring to Ashley 521; and Fig. 7 to Ashley's "probably original" Tweenie, 525. All quite distinct knots. The last of these is the good-looking knot adopted by one of us (DM) for letter 'A' in the Alphabend (K.M. issue 4) and for number 3 in Knots Count (K.M. issue 13).

Preview

Following his popular Guild publication "Introduction to Knot Tying and Fancy Work" (obtainable from Ivy Blandford, price £3 excl. p. & p.), knot craftsman Stuart E. GRAINGER is preparing a sequel on splices and lanyard knots. We await it eagerly...meantime, he gives us a preview (overleaf) of just one item which will be included

Make a Simple Start

with Stuart E. Grainger

NOW AVAILABLE
'SOME SPLICES &
LANYARD KNOTS' @ £2.60P.

A start of interlocked bights, followed by a Crown of pairs, can be turned into a handsome and useful knot, believed to be unpublished hitherto.

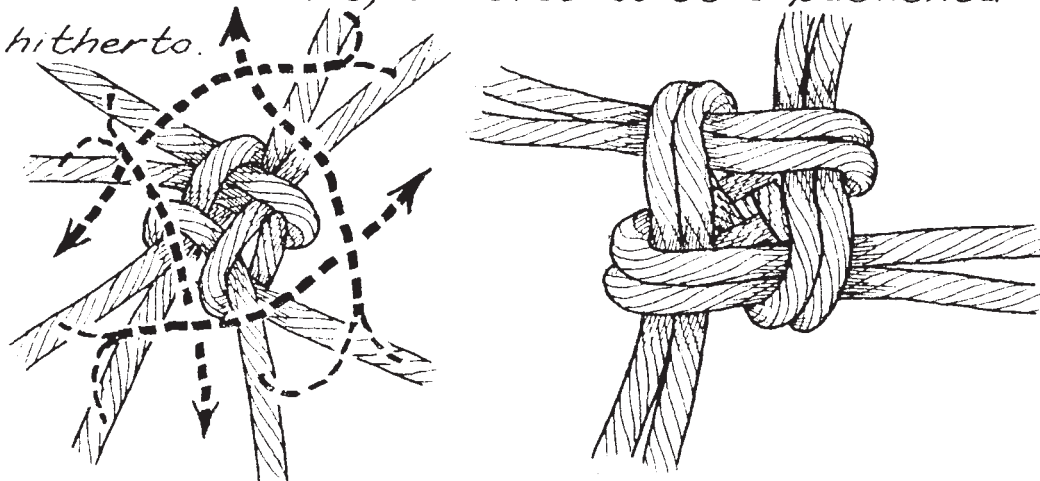

After completing and tightening the Crown of pairs, turn the whole knot over, upside down, when it should appear like this, with a single Crown on top of the double one. Each pair of strands is then tucked beneath the side of the single Crown that is nearest to it, emerging in the centre of the knot. Three, four or five pairs

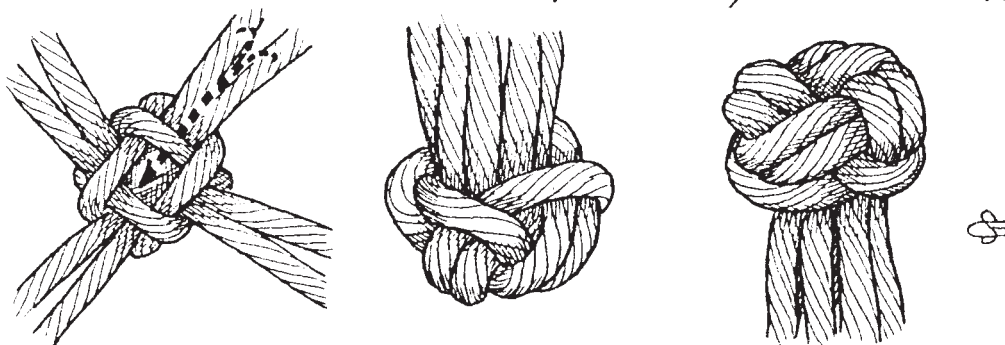

of strands can be tied as illustrated; more than five pairs require a core. Because all the strands are gathered centrally beneath the knot, it makes a good starting point for round, square or Crown Sennit in an even number of strands.

Preview of a forthcoming
Guild publication

